



4/8/16-CH DVR CD-RW

PDR-6040/6080/6160 A/S

INSTRUCTION MANUAL

Summary

Merit LILIN 6 series MPEG-4 DVRs are designed to meet the demands for complete range of DVRs including 4-channel, 8-channel, and 16-channel in one system platform. Adopting same system platform, it gives flexibility and capability for users in expanding systems for future without considering compatibility. Merit LILIN 6 series MPEG-4 DVRs adopt high compression rate MPEG-4 engine for video streaming. The combination uses of Group of Pictures (GOP) and Noise Reduction Filter (NRF) at night maximize storage utilization.

Storage system of the DVRs can be extended by using cost-effective Merit LILIN PSH-100 RAID system to gain up to 4 TB in size. SATA interface provides faster HDD access speed and prevents mechanical failure caused by 40-pin IDE connector. Video data file recovery and monitoring technologies secure the data file from power failure. Various backup plans including DVD/RW drive, USB flash disk, and FTP file download allow the user to operate file backup task anywhere.

Web interface provides network connectivity via Internet browser. Complete DVR features including remote file backup configurable from the web interface, there is no need for on-site maintenance. Free central management system (CMX) allows to digitally manage DVRs in control centers remotely. By simple mouse click, operator can gain live video worldwide. Plug-n-play RJ-45 3D joystick keyboard support, cascading camera name, easy-to-setup DVRs daisy chain connection via RJ-45, addressable DVR ID, and IR receiver extension provide the easiest way in setup a large-scale DVR systems.

Powerful MPEG-4 compression technology, complete storage and backup plans, full digital and analog system solutions, easy-to-use user interface, and full range accessories support, the new Merit LILIN 6 series MPEG-4 standalone digital video recorder is the only choice for surveillance system.

Major Features

- MPEG-4 compression engine
- Built-in VGA with intellectual motion adoptive refinement and vivid image enhancement
- HTTP web-based interface including DVR configuration, PTZ control, playback, and live monitoring
- Up to 480(NTSC)/400(PAL) frames per second in live
- Frame rate and video quality configurable each channel
- Extra spot output with quad and OSD support
- 4-channel audio inputs and 1 audio output
- Network audio & backup audio supports
- SATA HDD support with external e-SATA connector for maximum 4TB recording capability
- Portable USB 2.0 flash disk, DVD/RW, or FTP backup with AVI or MPEG-4
- Easy-to-use jog, shuttle, mouse, and 3D joystick
- Daylight saving time (DST)

Trademarks and registered trademarks

Microsoft, Windows 2000, Windows XP, Internet Explorer are registered trademarks of Microsoft Corporation in the U.S. and/or other countries.

Windows Media Player is registered trademarks of Microsoft Corporation in the U.S. and/or other countries.

Adobe and Adobe PDF are registered trademarks of Adobe Systems Incorporated in the U.S. and/or other countries.

JavaScript and all Java-based trademarks and logos are trademarks or registered trademarks of Sun Microsystems, Inc. in the U.S. and/or other countries.

Linux, Macintosh, Mozilla, Netscape Navigator, are registered trademarks of the respective holders.

Pelco is a trademark of Pelco - Clovis, CA, and may be registered in certain jurisdictions.

Other names of companies and their products mentioned in this manual may be trademarks or registered trademarks of their respective owners.

Caution

- **Do not drop or strike this equipment**
- **Do not install the equipment near any naked flames or heat sources**
- **Do not expose this unit to rain, moisture, smoke or dust environment**
- **Do not cover the opening of the cabinet with cloth and plastic or to install this unit in poor ventilated places. Allow 10cm between this unit and its surroundings**
- **Do not continue to operate the unit under abnormal conditions such as detection of smoke, strange smell or no display on screen while power is turned on**
- **Do not touch the power connection with wet hands**
- **Do not damage the power cord or leave it under pressure**
- **Do not operate this unit near magnet, speaker system, etc., to avoid unnecessary magnetic interference**
- **Connection cables should be grounded properly**

CAUTION
**RISK OF EXPLOSION IF BATTERY IS REPLACED
BY AN INCORRECT TYPE.**
**DISPOSE OF USED BATTERIES ACCORDING
TO THE INSTRUCTIONS**



TABLE OF CONTENTS

CHAPTER 1. SYSTEMS OVERVIEW	6
Chapter 1-1. Front Panel	6
Chapter 1-2. Rear View	8
Chapter 1-3. System LED Status Panel	9
Chapter 1-4. Remote controller	10
Chapter 1-5. Jog & Shuttle	11
Chapter 1-6. Mouse System.....	11
Chapter 1-6-1. Mouse Menu	12
Chapter 1-7. Active Camera	12
CHAPTER 2. DVR OPERATIONS	14
Chapter 2-1. Sequential Display.....	14
Chapter 2-2. Freeze	14
Chapter 2-3. Zoom	14
Chapter 2-4. CH+ & CH-	15
Chapter 2-5. Audio & Mute	15
Chapter 2-6. Addressable DVR Control Button	15
Chapter 2-7. NTSC/PAL	15
Chapter 2-8. Language.....	15
Chapter 2-9. ESC/Shutdown Procedure.....	15
Chapter 2-10. OK/Cancel Button.....	15
CHAPTER 3. PTZ CONTROL	16
Chapter 3-1. Instant PTZ Controllable Mode.....	16
Chapter 3-2. Remote Controller & PTZ	16
Chapter 3-3. Recall Presets	16
CHAPTER 4. RECORDING	17
Chapter 4-1. Start Recording.....	17
Chapter 4-2. Manual Recording	17
Chapter 4-3. Schedule Recording	17
Chapter 4-4. Alarm Switch Activation Recording.....	17
Chapter 4-5. Motion Detection Recording	17
CHAPTER 5. PLAYBACK	18
Chapter 5-1. Time Search	18
Chapter 5-2. Event Search	18
Chapter 5-3. REC Search.....	19
Chapter 5-4. Other Playback Features.....	19
CHAPTER 6. MENU SYSTEM	21
Chapter 6-1. Setup Menu	21
Chapter 6-2. Camera Setup	21

Chapter 6-2-1. Camera Name	21
Chapter 6-2-2. Channel Enable	22
Chapter 6-2-3. Video Setup	23
Chapter 6-2-4. Video Loss Detection	23
Chapter 6-2-5. Noise Filter.....	23
Chapter 6-3. Monitor Setup	23
Chapter 6-3-1. Main Alarm Switching	25
Chapter 6-3-2. Sequence Time	25
Chapter 6-3-3. SPOT/QUAD Sequence	25
Chapter 6-3-4. SPOT/QUAD Sequence Time.....	25
Chapter 6-3-5. SPOT Alarm Switch Time.....	25
Chapter 6-4. Record Setup.....	25
Chapter 6-4-1. Record Quality	25
Chapter 6-4-2. Frame Rate.....	26
Chapter 6-4-3. Recording Mode	26
Chapter 6-4-4. Audio.....	26
Chapter 6-4-5. Pre-alarm Recording.....	26
Chapter 6-4-6. Post-alarm Recording	26
Chapter 6-4-7. Resolution.....	26
Chapter 6-4-8. GOP.....	27
Chapter 6-4-9. Schedule.....	27
Chapter 6-4-10. HDD Overwritten.....	27
Chapter 6-4-11. Limited Recording	27
Chapter 6-5. Alarm Setup	28
Chapter 6-5-1. Alarm Input Type	28
Chapter 6-5-2. Motion Enable.....	28
Chapter 6-5-3. Sensitivity.....	28
Chapter 6-5-4. Motion Area Set	28
Chapter 6-5-5. Motion Tracer.....	29
Chapter 6-5-6. Alarm Time.....	29
Chapter 6-5-7. Buzzer Enable	29
Chapter 6-5-8. Button Sound.....	29
Chapter 6-6. System Setup	30
Chapter 6-6-1. Date/Time	30
Chapter 6-6-2. HDD Information	31
Chapter 6-6-3. Password/Access	31
Chapter 6-6-4. LOG View	32
Chapter 6-6-5. Factory Reset	33
Chapter 6-6-6. DVR/RS-485 ID	33

Chapter 6-6-7. Video System.....	33
Chapter 6-6-8. Firmware Update	33
Chapter 6-6-9. Language.....	34
Chapter 6-6-10. Live Audio	34
Chapter 6-7. Network	35
Chapter 6-7-1. Port Number	35
Chapter 6-7-2. DDNS.....	35
Chapter 6-8. PTZ Setup	35
Chapter 6-8-1. PTZ Model & Baud Rate	36
Chapter 6-8-2. Preset Setup	36
Chapter 6-8-3. Preset	36
Chapter 6-8-4. Dwell	36
Chapter 6-8-5. Speed.....	36
Chapter 6-8-6. Position	37
Chapter 6-8-7. IRIS & Auto IRIS	37
Chapter 6-8-8. Focus & Auto Focus.....	37
Chapter 6-8-9. Save Presets.....	37
Chapter 6-8-10. Clear All Preset	37
Chapter 6-9. Backup.....	38
Chapter 6-9-1. FTP Download	38
CHAPTER 7. FILE PLAYBACK.....	39
Chapter 7-1. Play AVI File on PC	39
Chapter 7-2. Play MPEG-4 Files	39
Chapter 7-2-1. Play MPEG-4 Audio	39
CHAPTER 8. NETWORK	41
Chapter 8-1-1. Configuration	41
Chapter 8-1-2. Internet Ports	41
Chapter 8-2. Access the DVR via Internet Browser.....	42
Chapter 8-2-1. Before Using Internet.....	43
Chapter 8-2-2. Logon	43
Chapter 8-2-3. Show Frame Size	43
Chapter 8-2-4. Split Window Display Buttons	44
Chapter 8-2-5. Hyper Link Panel	44
Chapter 8-2-6. Playback Over Network	44
Chapter 8-2-7. Save JPEG file.....	46
Chapter 8-2-8. Network Audio.....	46
Chapter 8-3. Configure the DVR via Web page	46
Chapter 8-3-1 Camera Setting.....	46
Chapter 8-3-2 Recording Setting	47

Chapter 8-3-3 Recording Schedule Table	47
Chapter 8-3-4 Alarm Setting	48
Chapter 8-3-5 Alarm E-mail.....	48
Chapter 8-3-6 Network Setting	49
Chapter 8-3-7 System Setting.....	49
Chapter 8-3-7-1 Timer	49
Chapter 8-3-7-2 User Setting	50
Chapter 8-3-7-3 System Status	50
Chapter 8-3-7-4 Firmware update	51
Chapter 8-3-8 Backup.....	51
CHAPTER 9. KEYBOARD CONNECTION.....	54
Chapter 9-1. Connection Between a DVR and a Keyboard.....	54
Chapter 9-2. Daisy Chain Connections of DVRs and a Keyboard.....	54
Chapter 9-3. Connections between a DVR and multiple PTZs.....	55
Chapter 9-4. Connection between multiple DVRs and multiple keyboards	56
Chapter 9-5. Operating a Keyboard for Controlling DVRs and PTZs	57
Chapter 9-5-1. Switch to DVR Control Mode.....	57
Chapter 9-6. Control DVR's Multiplexer Features.....	57
Chapter 9-7. Control DVR's Menu Setup	58
Chapter 9-7-1. OK or Cancel button in Submenu System.....	59
Chapter 9-8. Control DVR Playback	59
Chapter 9-9. Control PTZ.....	60
Chapter 9-10. Control a DVR's Spot Monitor.....	60
APPENDIX.....	62
APPENDIX A. Connect to External SATA RAID	62
APPENDIX B. Connect External Alarm Switches.....	63
APPENDIX C. RS-485 Input and Output Pin Assignment.....	64
APPENDIX D. Hard Disk Drive Support List	64
APPENDIX E. Supported DVD/RW Drive	65
APPENDIX F. Hard Disk Recording Table.....	65
SPECIFICATION.....	66

CHAPTER 1. SYSTEMS OVERVIEW

Chapter 1-1. Front Panel

Front View of PDR-6160 & PDR-6080

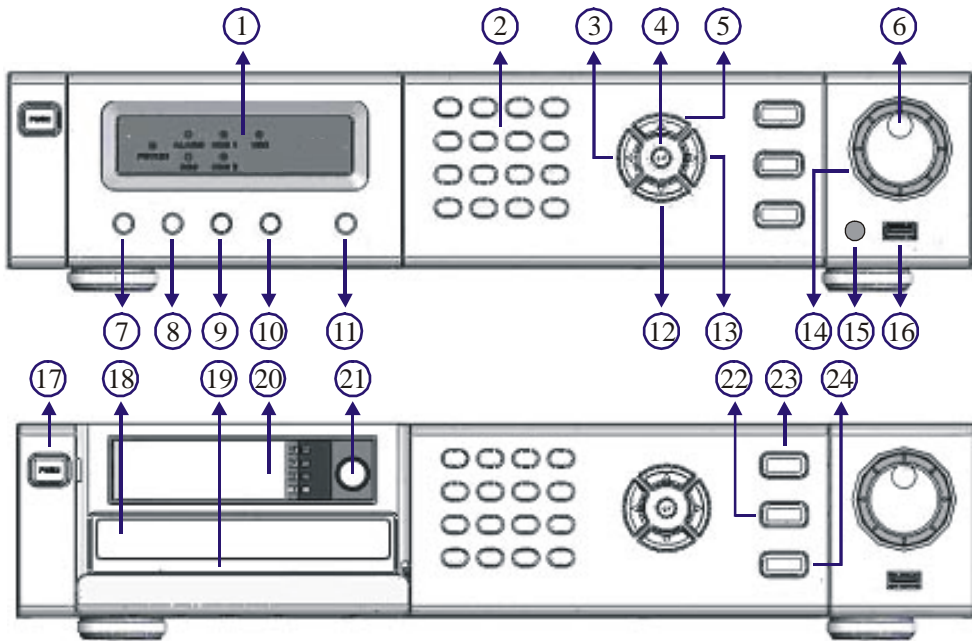

Front View of PDR-6040

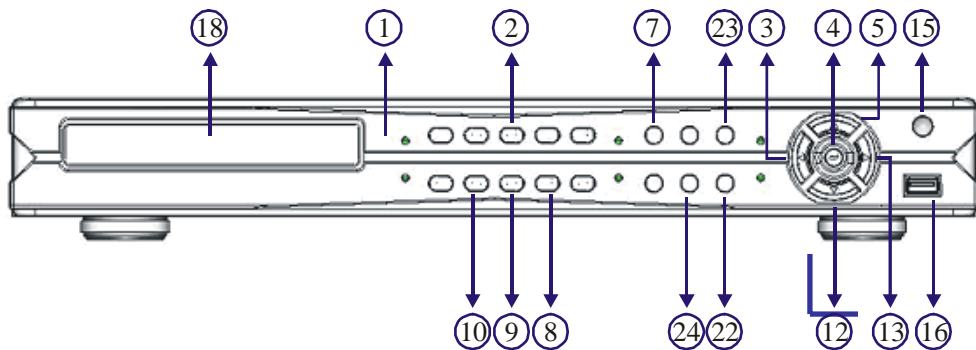

1. LED status panel

Please see system LED status panel.

2. Split-display/camera buttons

- a. 4, 8, 9, 13, 16 split-display when mode switch is on (PDR-6160 & PDR-6080 only)
- b. Camera selection mode

3. Left button

- a. Move cursor left at menu setup.
- b. Pan left at PTZ control mode.
- c. Decrease a value.

4. Enter button

- a. Enter operation in menu setup.
- b. Instant PTZ camera selection at live mode.
- c. Camera active mode

5. Up button

- a. Move cursor up in menu.
- b. Tilt up at PTZ control mode.

6. Jog dial (PDR-6160 & PDR-6080 only)

- a. Play recorded image frame by frame at playback mode.
- b. Perform zoom in and out on a PTZ device at live mode.

7. Rec button

Start recording operation or stop the recording task.

8. Play button

- a. Invoke playback selection menu.
- b. Replay after FF, FR, Pause, stepping when playing video.

9. Pause button**10. Stop video playback button****11. Mode switch for split-display or camera selection**

(PDR-6160 & PDR-6080 only)

12. Down button

- a. Move cursor down at menu mode.
- b. Tilt down at PTZ control mode.

13. Right button

- a. Move cursor right in menu.
- b. Pan right at PTZ control mode.
- c. Increase a value.

14. Shuttle ring (PDR-6160 & PDR-6080 only)

- a. Fast forward video at playback mode
- b. Instant video FR or instant event list at live mode

15. IR receiver**16. USB 2.0 connector**

USB flash disk

17. Storage panel opening button**18. Built-in DVD/RW drive****19. Emergency ejecting hole for DVD/RW tray****20. Removable HDD tray****21. Removable HDD lock****22. Menu button****23. ESC/shutdown button****24. Backup button**

Chapter 1-2. Rear View

Rear View of PDR-6160

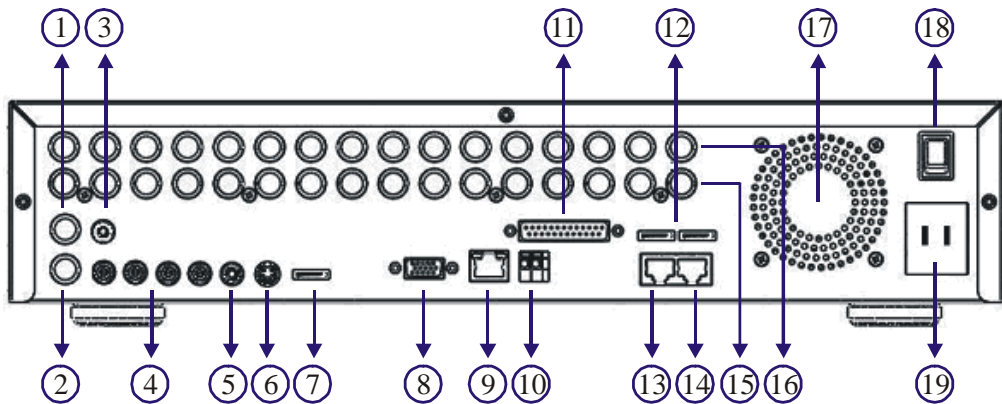

Rear View of PDR-6080

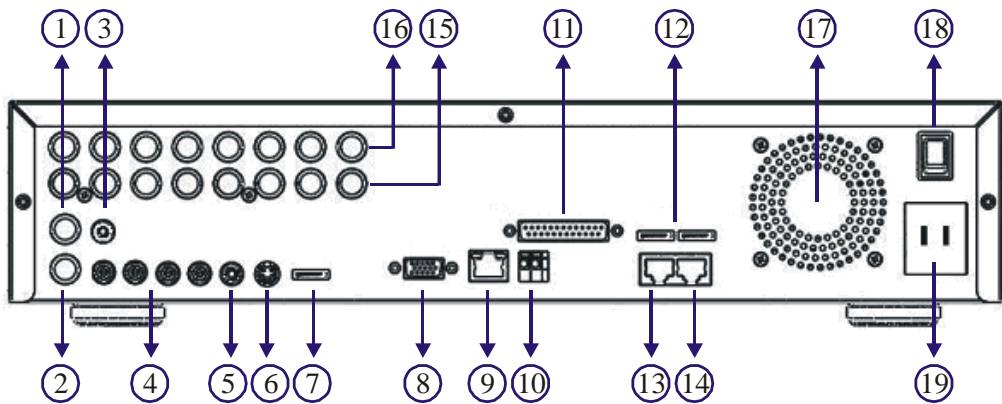

Rear View of PDR-6040

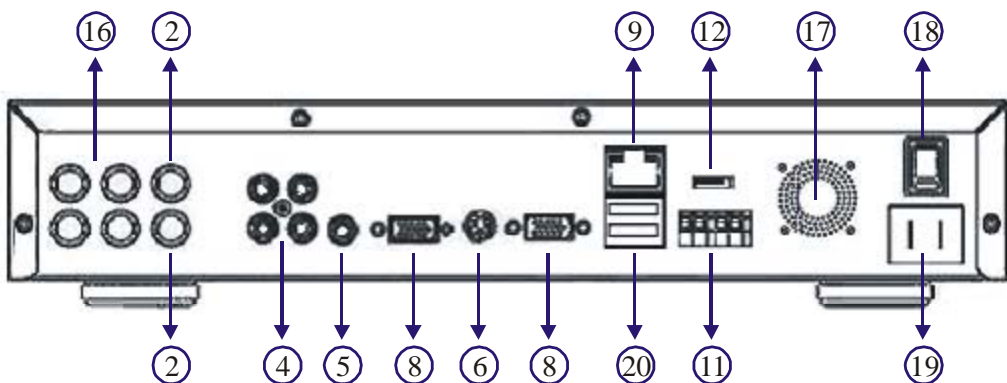

1. **Spot/quad output**
 - a. Spot/quad accessible by keyboard.
 - b. Each spot output can be programmable for alarmed camera display and sequence display.
2. **Main output**
3. **External IR receiver (RCA)**
4. **Audio inputs**
Four RCA audio connectors
5. **Audio output**
6. **PS/2 mouse**
7. **USB mouse**
8. **VGA output**
9. **Network RJ-45 connector**
10. **RS-485 out**—PTZ devices
11. **Alarm I/O**
Alarm input switches, 1 N/O alarm output, and 1 N/C alarm output
12. **e-SATA connectors**
Two e-SATA (PDR-6160 & PDR-6080) connectors for external SATA RAID
One e-SATA for PDR-6040
13. **RJ-45 Keyboard-in (PDR-6160 & PDR-6080 only)**
Connected from previous DVR's keyboard output in daisy chain.
14. **RJ-45 Keyboard-out**
Connect to the next DVR's input. RJ-45 connector
15. **Looping**—camera looping
16. **Video in**—16-channel analog video
17. **Fan**
18. **Power switch**
19. **Power connector**
AC 110V or 220V power input
20. **Mouse input (top) / Reserved (bottom)**

Chapter 1-3. System LED Status Panel

System LEDs are meaningful while operating the DVR. The status of each LED is described as in the following table:

PDR-6160 and PDR-6080

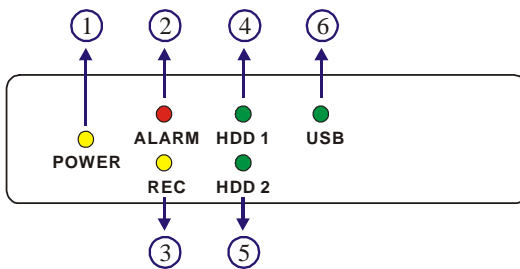

PDR-6040

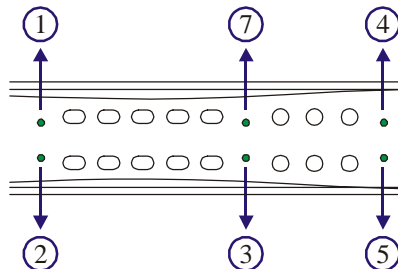

Item	LED	Description	Color
1	POWER	DVR power on/off indicator	Yellow
2	ALARM	External alarm switches indicators when motioned or alarmed	Red
3	REC	Recording indicator	Yellow
4	HDD 1	Master HDD recording indicator	Green (blinking)
5	HDD 2	Slave HDD recording indicator	Green (blinking)
6	USB	USB portable disk connected indicator	Green (blinking)
7	BACKUP	Backup LED indicator (PDR-6040 only)	Green (blinking)

Chapter 1-4. Remote controller

The button arrangement of the remote controller is designed for easy-to-use purposes. Buttons are separated in regions based on their features including DVR operational keys, pan, tilt, and zoom camera device (PTZ) keys, numerical keys, and PTZ buttons.



DVR operational keys (gray area)	
MENU	Setup menu
ESC	Escape/exit
ZOOM	Digital video zooming
REC	Record/stop recording
FREEZE	Live video freeze
	Pause
	Playback
	Stop
	Fast forward
	Fast rewind
	Next single channel
	Previous single channel
	4 split display
	8 split display
	9 split display
	13 split display
	16 split display
	PIP mode
SEQ	Sequential display
MUTE	Mute
AUDIO	Audio on
BACKUP	Video backup
DVR	Addressable DVR control
NTSC/PAL	Video system
LANGUAGE	Language selection

PTZ features (yellow area)		DVR & PTZ hybrid keys (blue area)	
Auto Pan	Perform auto pan feature		Move up/tilt up
Zoom in	Zoom in of a fast dome camera		Move down/tilt down
Zoom out	Zoom out of a fast dome camera		Move left/pan left
Preset	Call preset of a fast dome camera		Move right/pan right
			Enter/set
Numerical keys (green area)			
0 to 9	Numerical keys		

Chapter 1-5. Jog & Shuttle

Jog & shuttle menu—The DVR adopts Jog & Shuttle mainly in menu system and video playback modes. In menu setup mode, rolling Jog is to move the cursor of the menu system up or down. Shuttle moves the cursor of the menu system left or right.

Jog & shuttle during video playback-- During video playback, Jog & Shuttle acts as conventional VCR for video stepping forward (rewind) and fast forward (rewind).



Instant rewind & event list modes—Turning shuttle ring left invokes Instant Rewind feature. Instant Rewind rewinds and plays the recorded video from the moment of the operation in backward. It allows that the operator can instantly review the video few seconds or few minutes ago.

Turning shuttle ring right invokes event list (Instant Event). Operator can quick scan through the event list for suspicious events. Instant Rewind and Instant Event features are identical by pressing **FF** or **FR** button on the remote controller or a keyboard in live monitoring mode.

Jog for PTZ mode—Dialing jog dial in clockwise for a controlled PTZ camera can perform zooming in action for the PTZ device. Dial jog dial in counter clockwise for zooming out operation of the PTZ camera.

Chapter 1-6. Mouse System

The DVR has both USB and PS/2 mouse interface. A user can connect either USB mouse or PS/2 mouse to operate the DVR. General mouse operations are described as below:

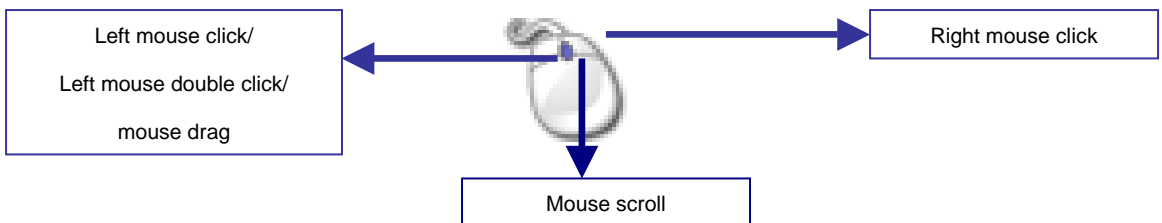

Left mouse click—In mouse menu system, mouse click can select a menu item. In window-division mode, click on a camera that is to select the camera in activation mode (active camera).

Left mouse double click-- In window division mode, click on a camera that can call the camera in full screen mode.

Mouse drag—For channel editing, perform mouse drag that can drag one camera and switch with another camera. In motion area setup mode, mouse drag can setup motion area.

Mouse scroll—In setup menu, mouse scroll can increase or decrease a value.

Right mouse click—Popup a submenu system or return to live in main menu.

Chapter 1-6-1. Mouse Menu

For using mouse menu, please use the mouse click on Menu item. The mouse menu shows on the screen for more system features.

LIVE
SETUP
PLAYBACK
MOTION
ZOOM
SEQUENCE
SHUTDOWN



Chapter 1-7. Active Camera

Active camera is shown in yellow color at the camera name/number in live monitoring mode. Once a camera is activated, the camera can be controlled for PTZ operation or for camera audio. Moving the active camera sequentially, one can simply press the **Enter** button on the remote controller, the keypad, or keyboard(s).



Chapter 1-8. Symbols & Icons







The DVR adopts symbols and icons for graphical user interface (GUI) design. These symbols and icons contain useful information in operating the DVR. All the symbols and icons are discussed in the rest of the chapter.

Task bar

The task bar shows up on bottom of the main monitor for indicating the operation status of the DVR while operating the remote controller, the mouse, the keypad, or a keyboard.



The icons of the DVR are described in the follow table:

Mouse menu	MENU
Controlled DVR ID/RS-485 ID	DVR: 002
The DVR's ID/RS-485 ID address	ID: 02
Manual recording mode	
Schedule recording mode	
Zoom mode	
Sequence mode	SEQ
Remote controller preset mode	
Network connection indicator	
Audio on/off indicator	

CHAPTER 2. DVR OPERATIONS

Most of the time, the DVR is operated at the surveillance/live mode. In live monitoring mode, the information of screen layout and symbols are described in this section.

SCREEN LAYOUT

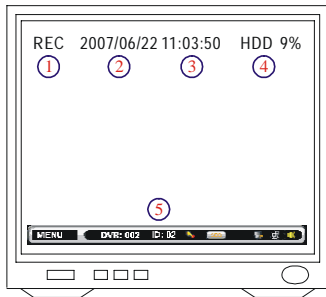

- ① Recording indicator
- ② Date
- ③ Time
- ④ HDD recording percentage
- ⑤ Task bar

Chapter 2-1. Sequential Display



The DVR provides multiplexer feature displaying each camera in full screen sequentially in specific time period. To perform sequential display, simply press **SEQ** button on the remote controller or a keyboard. The sequence icon shows on the task bar for indicating the DVR is in sequence status. To perform sequence using mouse, please click on Mouse Menu->Sequence.

Chapter 2-2. Freeze



In live monitoring and playback modes, the DVR provides screen-freezing feature in which suspicious individuals can be determined. To freeze the screen, press Freeze button on the remote controller. Press the button again to cancel this operation.

Chapter 2-3. Zoom



The DVR provides digital zooming capability in screen freezing, live monitoring, and video playback modes. To perform this feature, press **Zoom** button on the remote controller. Once the DVR is in zooming status, press **Up**, **Down**, **Left**, or **Right** buttons to move the zooming window around to view other portion of the channel.

Press the **Zoom** button again can cancel the zooming window and back to normal screen.

To perform zoom feature using a mouse, please first double click on a camera channel for camera's full screen. Once the camera is in full screen mode, perform mouse drag on the video.

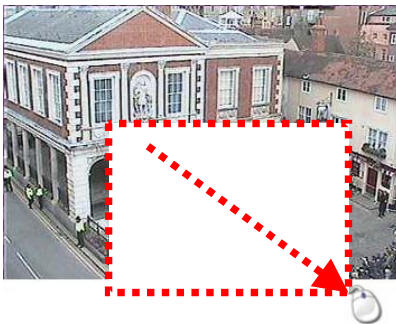

Chapter 2-4. CH+ & CH-



In case of scanning through cameras in full screen, channel buttons, **CH+** & **CH-** can be used to monitor all cameras.

Chapter 2-5. Audio & Mute



Once the audio channel is properly setup, the DVR can output the live audio. To disable live audio, one can press **Mute** button. To enable live audio, press **Audio** button.

Chapter 2-6. Addressable DVR Control Button



To control one of the DVRs using only one remote controller, please press on the addressable **DVR** control button followed by the DVR ID. The rest of the DVRs are in sleeping mode until one of the DVRs gets called.

Chapter 2-7. NTSC/PAL



To change video system, press on **NTSC/PAL** button. Password is required if a user presses on this button.

Chapter 2-8. Language



The DVR provides multi-language on screen display (OSD) support. To change from one language to another, simply press on **Language** button.

Chapter 2-9. ESC/Shutdown Procedure

To properly shutdown the DVR, please press ESC/Shutdown button for a second. A password dialog box shows up. Please provide administrator password to perform the task. Power off the DVR without proper shutdown procedure that it may corrupt a video file. File recovery procedure may start to recovery the video file when booting up the system.

Chapter 2-10. OK/Cancel Button

The DVR has OK/Cancel operation in menu/submenu system. To perform this operation, the user can press Menu for OK or ESC for cancel on the keypad or the remote controller. For keyboard, please press **SET** button for OK or **CANCEL** button for cancel.

CHAPTER 3. PTZ CONTROL

PTZ device can be controlled in live monitoring mode and PTZ setup mode via the keypad and/or the remote controller. The rest of the chapter describes the ways of controlling PTZ devices using the keypad and a remote controller.

Chapter 3-1. Instant PTZ Controllable Mode

Instantly controllable PTZ camera (active camera) is shown in yellow color at the camera name/number in live monitoring mode indicating that the camera can be instantly controlled for PTZ operations. Moving the active camera sequentially, one can simply press the **Enter** button on the remote controller. Once a camera is in active mode (text in yellow), major PTZ features can be easily performed.

Chapter 3-2. Remote Controller & PTZ

PTZ buttons are framed in yellow that contain auto panning, zooming, and zooming out. Other PTZ and DVR buttons are shown in blue on remote controller. The details are described as below:



- ① Tilting the PTZ device up
- ② Tilting the PTZ device down
- ③ Panning the PTZ device left
- ④ Panning the PTZ device right
- ⑤ Perform auto panning of the PTZ device
- ⑥ Perform zooming in of the PTZ device
- ⑦ Perform zooming out of the PTZ device
- ⑧ Calling presets

Chapter 3-3. Recall Presets

To call a preset, please follow the following instructions:



- Press **Preset** button to enable the calling preset mode.
- In Preset mode, preset 01 to 64 directly to recall preset points of the PTZ device.

CHAPTER 4. RECORDING

Chapter 4-1. Start Recording

The DVR automatically performs recording task after power on. Press **REC** button on the keypad or the remote controller that it can change the recording mode from schedule recording to manual recording. Press **REC** button again. The DVR returns back to schedule recording again.



Chapter 4-2. Manual Recording

Manual recording is equivalent to emergency recording. In manual recording mode, the DVR records all the cameras based on recording frame rate. In many cases, there might be a situation. A user might want to record all the cameras for suspicious events. Manual recording can now be used for an emergency. If there are motion triggerings or alarm switches set for the DVR, the events can be recorded in the DVR's event log.

Chapter 4-3. Schedule Recording

For storage consideration, there are many applications that may be required to record video after motion triggerings or alarm activations. Schedule recording can be used that the DVR records video based on motion or alarm triggerings for certain hours. The schedule table can be preprogrammed to meet the recording requirement.

Chapter 4-4. Alarm Switch Activation Recording

Recording operation can be triggered by an external alarm switch. An external alarm switch can activate the DVR for recording. Proper settings such as Alarm Rec Duration and activation type (N/O or N/C) should be configured before operation. Once one of the alarm switches gets triggered, the alarm icon (yellow bell) shows at the bottom of each camera channel.

Chapter 4-5. Motion Detection Recording

Motion detection is very useful feature of the DVR that the intrusion detection of a camera can be detected. Motion detection recording sensors motion variation, and it triggers the DVR to perform recording task. Once motion detection is activated, the motioned channel shows an alarm icon (little man in yellow) on the screen to inform users.

CHAPTER 5. PLAYBACK

To playback, please press **Play** button on the remote controller, a keyboard, or the keypad. A playback message box shows up for searching video clips. The details are described in the following sections:

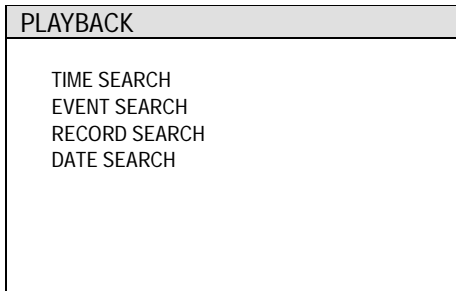

Chapter 5-1. Time Search

Time search feature can perform date and time search based on recorded video data. This feature is very easy-to-use, and it allows a user to perform video searching task throughout two hard disk drives. To perform time search operation, simply press **Left** or **Right** button on the highlighted date or time field. To change the date and time, please press **Up** or **Down** button.



Chapter 5-2. Event Search

Event list contains information including date, time, event type, and camera channel for the event. There are external alarm event and motion alarm event that can be found in event list. To filter out events, please set starting and ending time in the event search dialog box. To view operation log, please see System->Log View for detail.

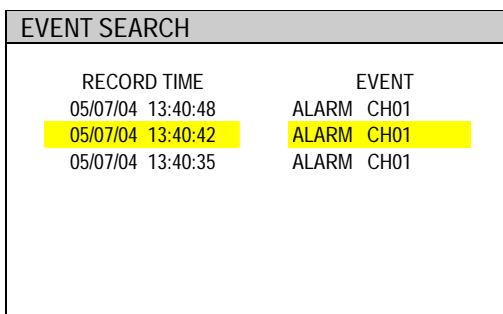

A screenshot of a dialog box titled "EVENT SEARCH". It displays a table with two columns: "RECORD TIME" and "EVENT". The table contains three rows of data. The second row is highlighted in yellow.

RECORD TIME	EVENT
05/07/04 13:40:48	ALARM CH01
05/07/04 13:40:42	ALARM CH01
05/07/04 13:40:35	ALARM CH01

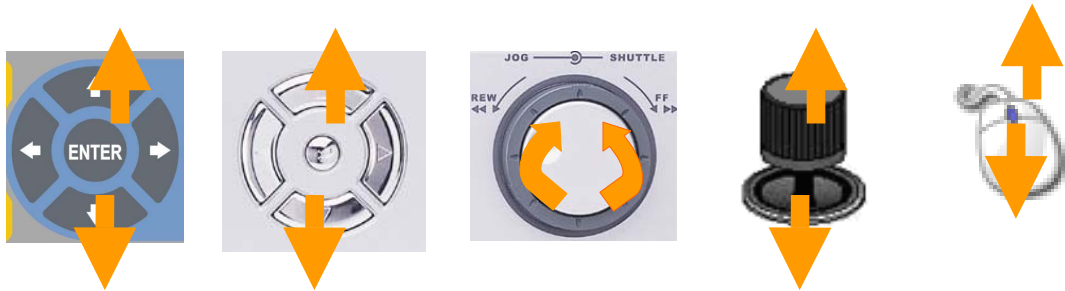

- To select an event list item, press **Up** or **Down** button.
- Press **Enter** button to play the video clips
- Press Shuttle Left or << (FR) for previous page. Press Shuttle Left or >> (FF) for next page on remote controller or keyboard.

Chapter 5-3. REC Search

REC SEARCH contains the list when a user presses **REC** button to activate manual recording operation. To play the REC Search list, please select Record Search item. A list of start recording shows up accordingly. Press **Up** or **Down** button to select list item for playback.

RECORD SEARCH		
RECORD TIME		
2007/07/04	13:39:47	MANUAL
2007/07/04	13:38:42	MANUAL

Chapter 5-4. Other Playback Features

Once one of above playback features is performed, features such as fast forward (FF), fast rewind (FR), pause, stop, step, and re-play can then be used.



FF: Press **Right** button, shuttle ring right on the front panel, or **FF** key on the remote controller to fast forward the playing video. The speed of fast forwarding is range from 2X ~ 6X of the original playback speed.



FR: Press **Left** button, shuttle ring left on the front panel, or **FR** key on the remote controller to fast rewind the playing video. The speed of fast rewinding is range from 2X ~ 6X of the original playback speed.



PAUSE & STEPPING: press **Pause** button while playing video that can pause the video. Once the video is in pausing mode, one can press **Left** or **Right** button on the DVR's keypad or the remote controller to play the video step-by-step.

Roll the Jog dial that can see the slow motion of the recorded video.



STOP: To stop video playback, press **Stop** button on the keypad or the remote controller. The DVR's screen switches back to playback main menu for other playback operations. Press **ESC** button again that it returns to live monitoring mode.

CHAPTER 6. MENU SYSTEM

Chapter 6-1. Setup Menu

Setup menu contains menu settings for camera, monitor, record, alarm, system, network, PTZ, and backup. The details of all the setup menu items are described in the rest of the chapters.

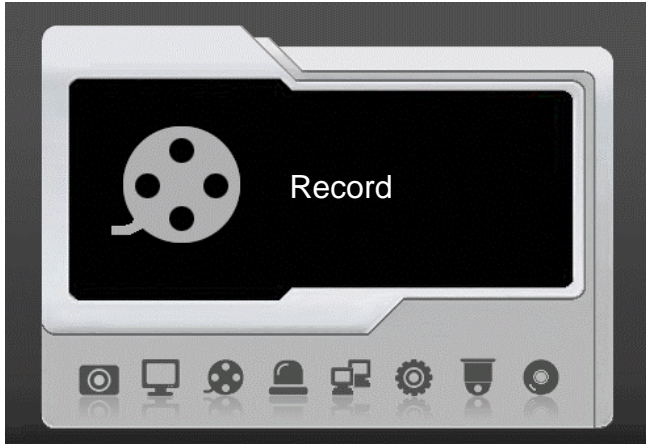

Chapter 6-2. Camera Setup

One can setup individual camera's settings such as camera name, video setup, sequence display, video loss detection, and noise filter. To setup above, please select Camera menu item in setup main menu.

CAMERA	
CAMERA SELECT	1
CAMERA NAME	Cam01
CHANNEL ENABLE	
VIDEO SETUP	
SEQUENCE TIME	
V. LOSS DETECTION	ON
NOISE FILTER	OFF

Chapter 6-2-1. Camera Name

A user can edit up to 12 characters for a camera name. To setup the camera name, please type the character using visual keyboard and press **Enter** button.

Visual Keyboard

INSERT: CAMERA													
1	2	3	4	5	6	7	8	9	0	-	=	←	<div style="border: 1px solid black; padding: 5px;"> Back Cursor Enter Page </div>
Q	W	E	R	T	Y	U	I	O	P	{	}	← →	
A	S	D	F	G	H	J	K	L	:	'	:	OK	
Z	X	C	V	B	N	M	<	>	/			← 2 →	
SPACE BAR													

The camera name can get shown not only on main monitor but also on web interface.



Cascading Camera Name

In many cases, DVRs may be connected and accessed by keyboard(s) via RS-485. There are up to 255 DVRs and 4080 cameras that can be addressed by keyboard(s). Editing camera name becomes a time consuming task. The DVR can be automatically renamed by using Cascading Camera Name (see System->DVR/RS-485 ID section).

Cascading Camera Name can match keyboard's operating or calling convention. For example, calling second DVR's first camera can be done by pressing #2 + DVR + #1 Camera or #17 Camera. Directly calling camera is more intuitive. Cascading Camera Name feature translates and modifies the second DVR's camera name to CH17 to CH32.

For large-scale project, devices may include analog matrix, main monitor outputs, and spot monitor outputs. The Cascading Camera Name feature is useful in identifying a camera. However, a user can still use meaningful camera name instead of numerical value to identify a camera.

Chapter 6-2-2. Channel Enable

Channel enable feature can disable the live video of a camera, and the channel can still perform video recording. For privacy or security considerations, irrelevant people may be prohibited to see the live video.

Chapter 6-2-3. Video Setup

Video setup can adjust video's contrast, brightness, hue, and saturation for each camera. To restore the default setting, please press Load Default menu item.

VIDEO SETUP	
CONTRAST	50
BRIGHTNESS	50
HUE	50
SATURATION	50
LOAD DEFAULT	

Chapter 6-2-4. Video Loss Detection

To enable or disable video loss detection, please set this option to be On or OFF. If the video signal is unstable and causes video loss, a user can disable this option. Unstable video signal may generate thousand of video loss events in one second. Temporarily turn this option Off that can improve DVR system performance.

Chapter 6-2-5. Noise Filter











Noise filter can filter out grain and noise generated by a camera in low light condition. Noise and artifacts of the video signal gets filtered out by the MPEG-4 engine. In general, noise filter can reduce video size at night. If all cameras are installed in low light condition, please set this option to On. To apply for only night condition, set the option to 18:00 PM to 6:00 AM (night).

Chapter 6-3. Monitor Setup

The DVR has intellectual motion adoptive refinement with vivid image enhancement VGA engine. The options can be set for the VGA engine including Adaptive Deinterlance, Edge Preserving, Moving Object Correct, File Mode, LTI/CTI, and B/W Level Extension.

MONITOR	
ADAPTIVE DEINTERLANCE	ON
EDGE PRESERVING	ON
MOVING OBJECT CORRECTION	ON
FILE MODE	ON
SHARPNESS ENHANCER	OFF
LTI/CTI	OFF
B/W LEVEL EXTENSION	OFF
MAIN MONITOR ALARM SWITCHING	
MAIN MONITOR SEQ TIME	
SPOT/QUAD SEQ	SPOT
SPOT/QUAD SEQ TIME	OFF

Each of the VGA settings is described in the following table:

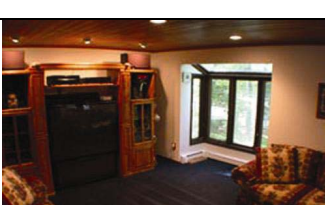
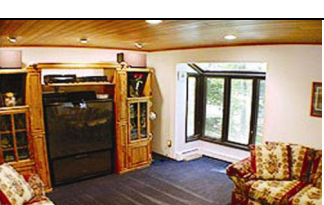
	OFF	ON
Adaptive deinterlace		
Edge preserving		
Moving object correction		
Film mode		
Sharpness enhancer		
LTI/CTI		
B/W Level Extension		

Chapter 6-3-1. Main Alarm Switching

The main monitor output can be configured in displaying camera's full screen. To enable this feature, please select the camera in camera selection box.

Chapter 6-3-2. Main Monitor SEQ Time



Sequence feature can multiplex each camera screen in full size in specific time period. Once the sequence time is set, press **SEQ** button on the remote controller or the keypad to activate the sequence feature.

Chapter 6-3-3. SPOT/QUAD Sequence

The DVR has a spot output. The spot output is equipped with a Quad processor. This unique Quad feature allows to review all the cameras quicker than spot sequence. To setup the sequence, please first assign spot or quad output. Specify SEQ TIME in seconds. Once above has been setup, the STOP/QUAD starts to perform sequence display.

Chapter 6-3-4. SPOT/QUAD Sequence Time

To specify Spot/Quad sequence time, please set this option.

Chapter 6-3-5. SPOT Alarm Switch Time

To specify Spot/Quad alarm switch time, please set this option.

Chapter 6-4. Record Setup

Record setup menu can setup features related to recording features such as recording quality, frame rate, recording mode, audio selection, alarm recording, recording resolution, group of pictures (GOP), schedule table, HDD overwritten, and limited recording.

RECORD	
CAMERA SELECT	1
QUALITY	HIGH
FRAME RATE	7 / 120
RECORD MODE	SCHEDULE
AUDIO	1
PREALARM REC	OFF
POSTALARM	5 SEC
RESOLUTION	CIF
GOP	4
SCHEDULE TABLE	
HDD OVERWRITTEN	YES
LIMITED RECORDING	

Chapter 6-4-1. Record Quality

The recording quality can be configured for each channel. To change the quality setting, press **Left** or **Right** button.

Chapter 6-4-2. Frame Rate

Each camera channel can be setup for its frame rate individually. To setup the frame rate, please press **Left** or **Right** button.

FRAME RATE					
CH1	8	← →	CH9	8	← →
CH2	8	← →	CH10	8	← →
CH3	8	← →	CH11	8	← →
CH4	8	← →	CH12	8	← →
CH5	8	← →	CH13	8	← →
CH6	8	← →	CH14	8	← →
CH7	8	← →	CH15	8	← →
CH8	8	← →	CH16	4	← →
<input type="checkbox"/> AUTO					
TOTAL: 120/120					

Chapter 6-4-3. Recording Mode

Each camera can be setup for schedule recording or no recording. Once the recording mode has been turned off, each recording mode including alarm, motion, or manual recording does not record.

Chapter 6-4-4. Audio

There are up to four audio inputs that can be recorded into the DVR. To setup audio recording, please assign the audio channel to a particular camera.

Chapter 6-4-5. Pre-alarm Recording

There are up to total 160 images held in memory buffer before an alarm is activated. If pre-alarm recording is enabled, the pre-alarm image buffer gets appended into the recording video.

Chapter 6-4-6. Post-alarm Recording

Post-alarm recording can record the video of a camera after a particular alarm/motion is triggered. To enable post-alarm recording, please set the post-alarm recording seconds for this option.

Chapter 6-4-7. Resolution

The DVR can provide 720 * 240 (field) or 360 * 240 (CIF) recording solutions. The default setting is at 360 * 240. To change recording resolution, please press **Left** or **Right** button.

Chapter 6-4-8. GOP

Group of Pictures (GOP) technology is widely used by dynamical streaming compression algorithm such as MPEG-4 and H.264. GOP technology contains one still image followed by dynamical streaming (P frame) . For example, GOP 4 means that there are 1 still image followed by 3 P frames. The P frame is just a small portion (dynamic part of the video) of the still image for reducing video size. Higher GOP means smaller video in size if the video source is static. If the video source changes dramatically such as PTZ camera in auto pan mode, it may results in bad video quality. In dynamically environment, please reduce GOP size.

Chapter 6-4-9. Schedule

Once the schedule has been setup, the DVR can record camera video based on the schedule table. The DVR's timer detects every second to check if it should start to record. To edit the schedule table, a user can press **Enter** button for editing mode. Press **Enter** button that can change recording mode, always, sensor, motion, or no record. For the Apply All setting, the user can use **Up** or **Down** button to select Apply All menu item. Press **Enter** button on Apply All menu item that can setup a recording mode for a week.

SCHEDULE												
	0	4	8	10	12	14	16	18	20	22	24	
▶ MON	■	■	■	■	■	■	■	■	■	■	■	■
TUE	■	■	■	■	■	■	■	■	■	■	■	■
WED	■	■	■	■	■	■	■	■	■	■	■	■
THU	■	■	■	■	■	■	■	■	■	■	■	■
FRI	■	■	■	■	■	■	■	■	■	■	■	■
SAT	■	■	■	■	■	■	■	■	■	■	■	■
SUN	■	■	■	■	■	■	■	■	■	■	■	■

■	ALWAYS	■	SENSOR
■	MOTION	■	NONE RECORDING
□	APPLY ALL		

Chapter 6-4-10. HDD Overwritten

The DVR can be setup for HDD circular recording. If the user does not want the HDD to be overwritten, please turn the option to be off.

Chapter 6-4-11. Limited Recording

In many countries, the HDD recording may be limited and can be only accessed for a certain period. Once the recorded data passes the period, the data can no longer be accessed.

Chapter 6-5. Alarm Setup

Alarm setup menu allows changing the settings of extern alarm switches, motion alarm, buzzer, and alarm recording duration. To change these settings, please enter Alarm setup menu and follow the instructions:

ALARM	
CAMERA SELECT	CH01
ALARM INPUT TYPE	OFF
ALARM ENABLE	OFF
MOTION SENSITIVITY	OFF
MOTION AREA SET	NORMAL
MOTION BUZZER TIME	05 SEC
ALARM REC TIME	05 SEC
BUZZER	ON
BUTTON SOUND	ON

Chapter 6-5-1. Alarm Input Type

The DVRs' alarm inputs can be configured as normal open (N/O) or normal close (N/C). The alarm input is one-to-one mapped to a camera respectively.

Chapter 6-5-2. Motion Enable

Motion Enable enables motion alarm activation, if the motion area has been set with proper motion sensitivity. Press **Left** or **Right** button at Motion Enable menu item to change the setting.

Chapter 6-5-3. Sensitivity

There are eight levels of sensitivity adjustable for motion alarm triggering, range from Very High to Very Low. Press **Left** or **Right** button to change the sensitivity setting.

Chapter 6-5-4. Motion Area Set

There are few ways to setup motion area. The detail setup sequence is described as follows:



	Keypad	Keyboard	Remote controller	Mouse
Step 1	Enter Motion Area Set menu item.			
Step 2	Press Menu button again for motion setup selection.			Right mouse click.
Step 3	Select "Motion Set" to define motion area(s)			Select a menu item using the mouse.
Step 4	Press Up, Down, Left, or Right to move cursor (cursor mode).			Move mouse for starting position.
Step 5	Press Enter button to start area selection			
Step 6	Press Up, Down, Left, or Right for an area			Mouse drag for an area
Step 7	Press Enter for cursor (cursor mode) and go to step 4 for second area. To exit the menu, please press Exit menu item/ Menu button.			Go to step 4 for second area. Selection Exit menu item to save changes and exit setup menu.

A user can also set or clear entire motion area by selecting Set All or Clear All menu item.

Chapter 6-5-5. Motion Tracer

Motion tracer can be used to determine the motion sensitivity. When motion tracer is set to on, the motion grids are shown in red to represent motion triggers.

Chapter 6-5-6. Alarm Time

Motion alarms and external alarm inputs can trigger the buzzer alarm. Buzzer time is adjustable from 0 to 99 sec. Press Left or Right button on Buzzer Time to adjust the time setting.

Chapter 6-5-7. Buzzer Enable

In case, the warning buzzer requires to be turned off. A user can disable the buzzer under System->Buzzer Enable menu item.

Chapter 6-5-8. Button Sound

To enable or disable button sound, please set button sound option.

Chapter 6-6. System Setup

The DVR system related settings such as date/time, HDD, restoring manufacturing default, video format, DVR/RS-485 ID, language, password authentication, and firmware update can be configured from system menu. To setup above features, please follow the following instructions:

SYSTEM	
DATE / TIME	
HDD INFO	
PASSWORD/ACCESS	
LOG VIEW	
FACTORY RESET	
DVR / 485 ID	OFF
VIDEO SYSTEM	NTSC
FIRMWARE	
LANGUAGE	ENGLISH
LIVE AUDIO	ON

Chapter 6-6-1. Date/Time

The DVR has built-in timer to record time information. One can choose different time format or disable the timer.

DATE / TIME	
TIME	18:16:17
DATE	2005 / 06 / 30
FORMAT	YYYY / MM / DD
DISPLAY	ON
TIME SYNC	KEYBOARD
DST	OFF

Time Sync

Time Sync feature allows the DVR to synchronize its timer system to PIH-931 keyboard. To synchronize DVR's timers to a PIH-931 keyboard, please set this option to Keyboard. PIH-931D keyboard starts to synchronize every 15 minutes.

Warning: Highly recommend to perform Time Sync feature before the DVR starts to record video.

Daylight Saving Time

The DVR provides Daylight Saving Time (DST) feature. This feature allows the DVR to change timer system based on Daylight Saving Time table.

Warning: Highly recommend to re-format HDD, if the timer has been set and the HDD has recorded video data.

Chapter 6-6-2. HDD Information

HDD INFO shows the following information:

1. Model number—The model number of the hard disk drive
2. Size—The capacity of the hard disk drive
3. Approximate recording hour—recording hours based on the HDD(s)
4. Approximate recording days—recording days based on the HDD(s)
5. Average frame size—Average picture size

HDD INFO	
PRI	MASTER
	SIZE
	SLAVE
	SIZE
SEC	MASTER
	WD
	SIZE
	250 GB
	SLAVE
	WD
	SIZE
	250 GB
HDD FORMAT	
APPROX REC HOURS	142
APPROX REC DAYS	7
RESET COUNTER	

HDD Format

To format HDDs, please select HDD Format menu item. Password is required for preventing unauthorized access. A warning message also gets prompted for formatting verification.

Please be alerted to this operation. It may erase not only event list data but also recorded video data. Press **Enter** button at HDD Format menu to format the hard disk drives.

Formatting hard disk drives may take several seconds based on the number of lists recorded.

Chapter 6-6-3. Password/Access

The DVR has three sets of password protection (accounts) preventing unauthorized access.

To activate password function, please turn Enable Password on or off at System->Password.

The password consists of four to eight digits for entering the DVR. The default passwords are admin, "1111", operator, "2222", and guest, "3333". The acceptable characters are 1 to 10 (0) and A to Z. To change the password setting, please press **Enter** at System->Password->Change Password.

PASSWORD/ACCESS	
USER	ADMIN
OLD PASSWORD	****
NEW PASSWORD	****
CONFIRM PASSWORD	****
PROPERTY	
ENABLE PASSWORD	OFF

Note: In case, forgetting your password, please contact your sales agent for master password.

Access Property

Each account can be assigned for access rights including video playback, menu setup, video backup, PTZ setup, network setup, and remote network playback. For an administrator, she or he can manage various access rights for other users.

PROPERTY	
PLAYBACK	ON
SETUP	ON
BACKUP	ON
PTZ SETUP	ON
NETWORK SETUP	ON
REMOTE PLAYBACK	ON

Chapter 6-6-4. LOG View

Operational event, video lose event, abnormal power off, and other DVR events can be reviewed by LOG View menu item. Events are described in the following table.

Event	Description
BOOTING	Power on
SHUTDOWN	DVR Shutdown
ABNORMAL OFF	Abnormal power off
FORMAT	Format HDD
V.LOSS	Camera video loss
WATCHDOG	Watchdog started
SET CAMERA	Set camera settings
SET MONITOR	Set monitor settings
SET RECORD	Set recording settings
SET ALARM	Set alarm settings
SET NETWORK	Set network settings
SET SYSTEM	Set system settings
SET PTZ	Set PTZ settings
SET BACKUP	Perform backup
ADMIN LOG	Administrator login
OPERATOR LOG	Operator login
GUEST LOG	Guest login
FILE RECOVERY	File recovery after abnormal power down

Chapter 6-6-5. Factory Reset

A user may want to restore manufacturing default settings. A confirm message shows up for final verification. To perform this task, please select Factory Reset at System->Factory Reset and press **Enter** button.

Note: Factory reset does not affect IP address, video system, and language settings.

Chapter 6-6-6. DVR/RS-485 ID

Each DVR can be assigned by a unique DVR/RS-485 ID accessed by the remote controller or PIH-931D keyboard. With a unique DVR/RS-485 ID set, the remote controller or PIH-931 keyboard issues commands to a particular DVR. The rest of DVRs are not affected by the remote controller or PIH-931 keyboard. To operate addressable DVR control feature, please refer to chapter 1 Addressable DVR Control Button.

To change DVR/RS-485 ID, press on **Left** or **Right** button on the front panel. Once DVR/RS-485 ID has been change, the cascading camera message box gets prompted.

Chapter 6-6-7. Video System

The DVR supports both NTSC and PAL video systems. The DVR allows switching from one video system to another without rebooting. To change video system, press **Left** or **Right** button at System->Video System.

Chapter 6-6-8. Firmware Update

Firmware update allows one to upgrade the DVR's firmware for improving system performance. To perform firmware update, press **Enter** on Setup->System->Firmware Update. There are two ways to perform firmware update via (1) USB flash disk at DVR site and (2) HTML interface via network.

To perform firmware update using USB flash disk, please follow the instructions:

- (1) Plug in portable USB disk at the DVR's USB port.
- (2) Press **Enter** button at Start Update Firmware.
- (3) After finishing transferring, remove the USB device and reboot the DVR.

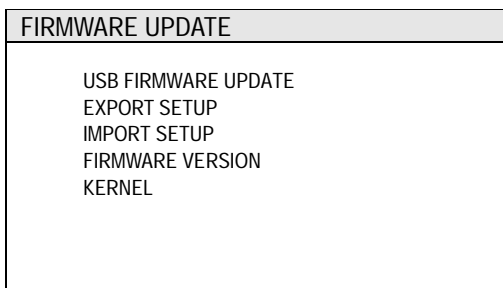

Prepare Firmware

To prepare firmware update, please create a directory, firmware, in the USB flash disk. The USB flash disk should contain file system FAT-16 or FAT-32. Please visit the web site at www.meritlilin.com to download the latest firmware and save the file in the directory mentioned above.

Start Update Firmware

To perform firmware update, please plug in the USB flash disk into the DVR. Select Start Update Firmware menu item and press **Enter** button. It will automatically transfer the firmware into the DVR. After transferring firmware, wait until "Please Reboot System" message gets prompted and reboot the DVR.

Export Setup

Export setup feature allows a user to export internal configuration into a system file, at USB flash disk's firmware directory. The file can later be imported to other machines. The imported machine's internal configuration gets updated based on the original DVR's configuration. To perform Export Setup, please select Export Setup menu item and press **Enter** button.

Import Setup

To perform Import Setup feature, please select Import Setup menu item and press **Enter** key. The configuration of the DVR gets updated based on the system file.

Version

Version menu item indicates the current version number of the DVR.

Chapter 6-6-9. Language

The DVR provides multi-language OSD support. A user can change his/her preferred language to operate the DVR. Press on **Left** or **Right** button to change the Language setting.

Chapter 6-6-10. Live Audio

To turn on or off live audio monitoring, please set Live Audio option.

Chapter 6-7. Network

The DVR allows a user to access the video via Internet or LAN. In order to connect to LAN or Internet, subnet mask, gateway, and IP address should be configured. Please consult your Internet provider or system administrator for above information.

NETWORK	
IP MODE	STATIC
IP ADDR	192 . 168 . 001 . 171
SUBNET MASK	255 . 255 . 255 . 0
GATWAY	192 . 168 . 001 . 001
HTTP PORT	80
VIDEO PORT	3100
MAC	00:0F:FC:00:00:03

Chapter 6-7-1. Port Number

For Internet connection, port number IP mapping technologies can be used for single IP address shared by multiple devices via a network router. Please consult your network administrator for this advanced network technique.

Note: Default Internet port numbers for the DVR are port 80 (HTML web pages) and port 3100 (video port)

Chapter 6-7-2. DDNS

To use domain name provided by DDNS server (www.dyndng.org), please first visit www.dyndns.org to register an account. After registration, please enter “host name”, “username”, and “password” in DDNS menu item at DVR side.

Note: Please use lower case for “host name”, “username”, and “password” for both DynDNS registration and DVR settings.

Chapter 6-8. PTZ Setup

The DVR can control up to 16 PTZ cameras. Using DVR’s keypad or the remote controller can access all these cameras. To setup PTZ connection, please follow the following instructions:

PTZ	
CAMERA SELECT	: 1
PTZ	: PIH 7625
PRESET ADJUST	
BAUD RATE	9600
DIRECT KEYBOR ACCESS	

Chapter 6-8-1. PTZ Model & Baud Rate

One can choose the model of PTZ devices by pressing **Left** or **Right** button. The DVR adopts this PTZ model's protocol and communicates with the PTZ device. Each PTZ device can be assigned by its PTZ protocol with different baud rate.

Model	Baud Rate	Number of Bytes
PIH-7000 (MLP1)	9600	3
PIH-7600 (MLP1)	9600	3
PIH-7625-3 (MLP1)	9600	3
PIH-7625-7 (MLP2)	9600	7
PIH-7622-7 (MLP2)	9600	7
Pelco D	2400~9600	None
Pelco P	2400~9600	None

Chapter 6-8-2. Preset Setup

A preset of a PTZ camera can be configured for manipulation during live monitoring. Panning, tilting, zooming, calling presets, auto panning, and other PTZ features provided by a PTZ camera can also be accessed during live monitoring mode. All the features should be configured before accessing PTZ functions. Please follow the rest of this chapter to setup a preset:.

PRESET SETUP	
PRESET SETUP	01
DWELL	000 SEC
SPEED	1
POSITION	
IRIS	
AUTO IRIS	
FOCUS	
AUTO FOCUS	
SAVE PRESET	
CLEAR PRESET	

Chapter 6-8-3. Preset

To define a preset, press **Left** or **Right** button on the keypad or the remote controller to change the preset number.

Chapter 6-8-4. Dwell

Define dwell of a preset. Dwell number ranges from 0 to 255 (the shortest to the longest).

Chapter 6-8-5. Speed

Define speed of previous preset to the next preset. The speed number ranges from 1 to 8 (the slowest to the fastest). The speed might vary based on different PTZ device's settings.

Chapter 6-8-6. Position

To adjust PTZ lens position, press **Enter** at Adjust Pos menu item. A PTZ screen keypad shows up as a reminder. Please press **Left**, **Right**, **Up**, or **Down** button on remote controller to move the PTZ lens. To zoom in and/or zoom out of the PTZ device, press **Zoom In** and/or **Zoom Out** on the remote controller or Jog at front panel.

Chapter 6-8-7. IRIS & Auto IRIS

To adjust IRIS, please press **Left** or **Right** button on IRIS option. For auto IRIS, press **Enter** on Auto IRIS option.

Chapter 6-8-8. Focus & Auto Focus

To adjust focus, please press **Left** or **Right** button on Focus option. For auto focus, press **Enter** on Auto Focus option.

Chapter 6-8-9. Save Presets

Once the above parameters are entered, the lens of the PTZ device should be in place with proper IRIS and focus set. To store the parameters permanently, please press **Up** or **Down** button to choose Save menu item. The position gets stored by each PTZ device programmatically. You can test the stored preset by switching back and forth on Preset menu item. To define other preset point, please repeat chapter 6-8-4.

In live monitoring mode, this preset can be recalled at any time. To recall a preset, please read Call Preset section for detail.

Chapter 6-8-10. Clear All Preset

To clear all the preset points of a PTZ device, please select Clear All Preset menu item. Press **Enter** key on the front panel or remote controller. The operation clears all the preset points.

Note: Please make sure that the RS-485 wires are properly installed and connected to the DVR. The PTZ device ID is adjusted to the DVR's camera number accordingly.

Chapter 6-9. Backup

The DVR provides various backup methods for performing backup task including USB flash disk, DVD/RW (advanced model), and FTP file download.

BACKUP	
DEVICE	DVD/RW
CHANNEL	ALL CHANNEL
START	2007/11/21 14:55
END	2007/12/21 14:55
EJECT / LOAD	
ERASE ALL USB FILE	
BLANK DVD	
<input type="checkbox"/> TRANSFORM TO AVI	
TOTAL	274 MB

To perform backup, please press **Left** or **Right** to select backup device type. Press **Enter** button on Channel option to select backup channel(s). Once the channel(s) has been selected, enter start backup and end backup time. The video size will be calculated in Total field. If an AVI backup file is needed, please select Transform to AVI option.

For DVD/RW backup, please purchase DVD+RW disk (recommended). Perform Blank DVD feature before starting DVD backup.

Note: Windows Media Player can play AVI file. However, only one channel can be exported.

Chapter 6-9-1. FTP Download

If backup device is set to File, important backup video can be stored in DVR's temporary buffer. The DVR has 2 GB internal storage space allocated for file backup. The backup files gets deleted automatically for the next time the backup task performed again.

To download the backup files, please use FTP program to download the video file to your PC. Please provide the account and password as "Admin", "Oper", and "Guest" in the FTP program to download the file(s). The user can also use integrated HTML interface for FTP file download.

CHAPTER 7. FILE PLAYBACK

To play a backup file from a PC, a user can export DVR's video to an AVI file or MPEG-4 file. The difference between AVI file and MPEG-4 files are that AVI file can be played by Windows Media Player Version 10 or above. However, there is only one single channel that can be review. To review multiple channels, MP4Player.exe built-in in the DVR can be used.

Chapter 7-1. Play AVI File on PC

To play the AVI file on a PC, simply double click on the DVR exported AVI file. Window Media Player loads the file and starts to play.

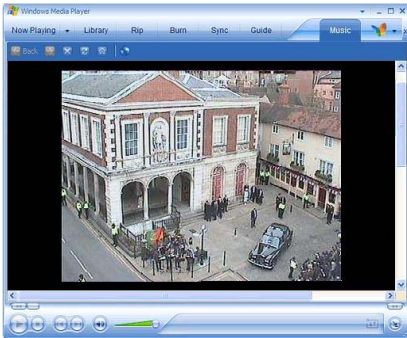

Note: To play AVI file, it requires Windows Media Player 10 or higher. If it can not still play the MPEG-4 AVI file, please download XviD from Internet or install XviD software decoder from product CD.

Chapter 7-2. Play MPEG-4 Files

The DVR can export MPEG-4 file to (1) USB flash disk, (2) DVD/RW, (3) File for FTP download. To play the exported MPEG-4 video files on a PC, please use MP4Player.exe . MP4Player.exe can be copied over the backup device whenever the backup task has been performed. The user can also download the application from the DVR's HTML interface.

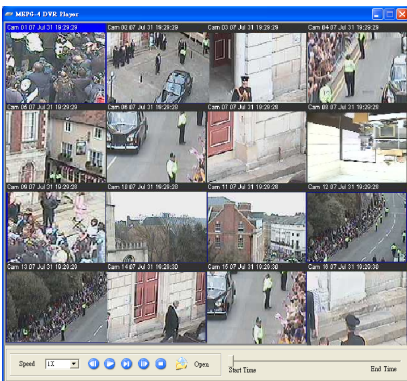

Chapter 7-2-1. Play MPEG-4 Audio

Double click on a channel in full screen for playing audio.

NETWORK

CHAPTER 8. NETWORK

There are two ways to access the DVR via network--Internet browser (web interface) or CMX application. All the features including live monitoring, menu setup, video playback, and file backup can be done by using web interface.

Chapter 8-1-1. Configuration

Make sure that network IP address, subnet mask, and gateway of the DVR are setup correctly. Always, consult your network administrator before installing DVR.

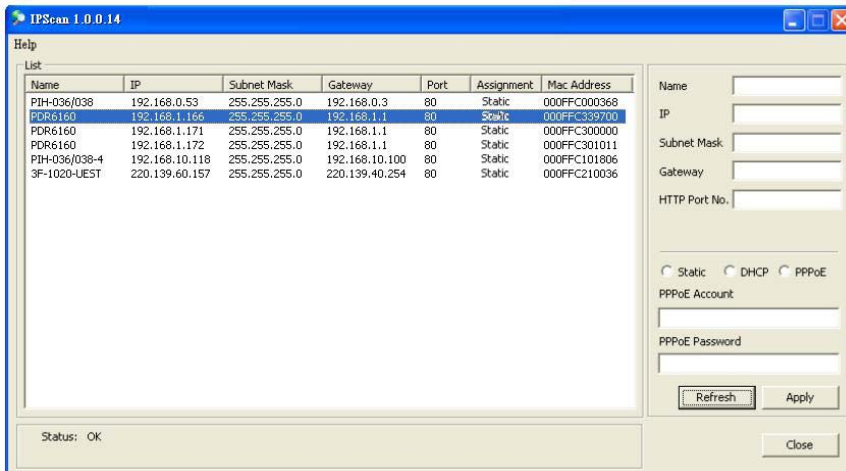

To setup IP address, a user can use IPScan utility to scan all the DVRs within a LAN. This powerful tool can help the user to monitor, to find, and to set IP configuration for all Merit LILIN's IP-based products.

Note: The default IP address of the DVR is 192.168.1.171

Chapter 8-1-2. Internet Ports

To access the DVR via Internet using a router, please make sure that IP Ports of the router (IP sharing device) are set. The DVR uses the following IP Ports by default:

Port 80—HTML web pages

Port 3100—Command port

Chapter 8-2. Access the DVR via Internet Browser

To access the DVR, a user can use Internet browser to get live and stored video via Internet. The DVR's web interface also provides features of PTZ access, split window display, and system configurations. General DVR web interface is described in the following figure:

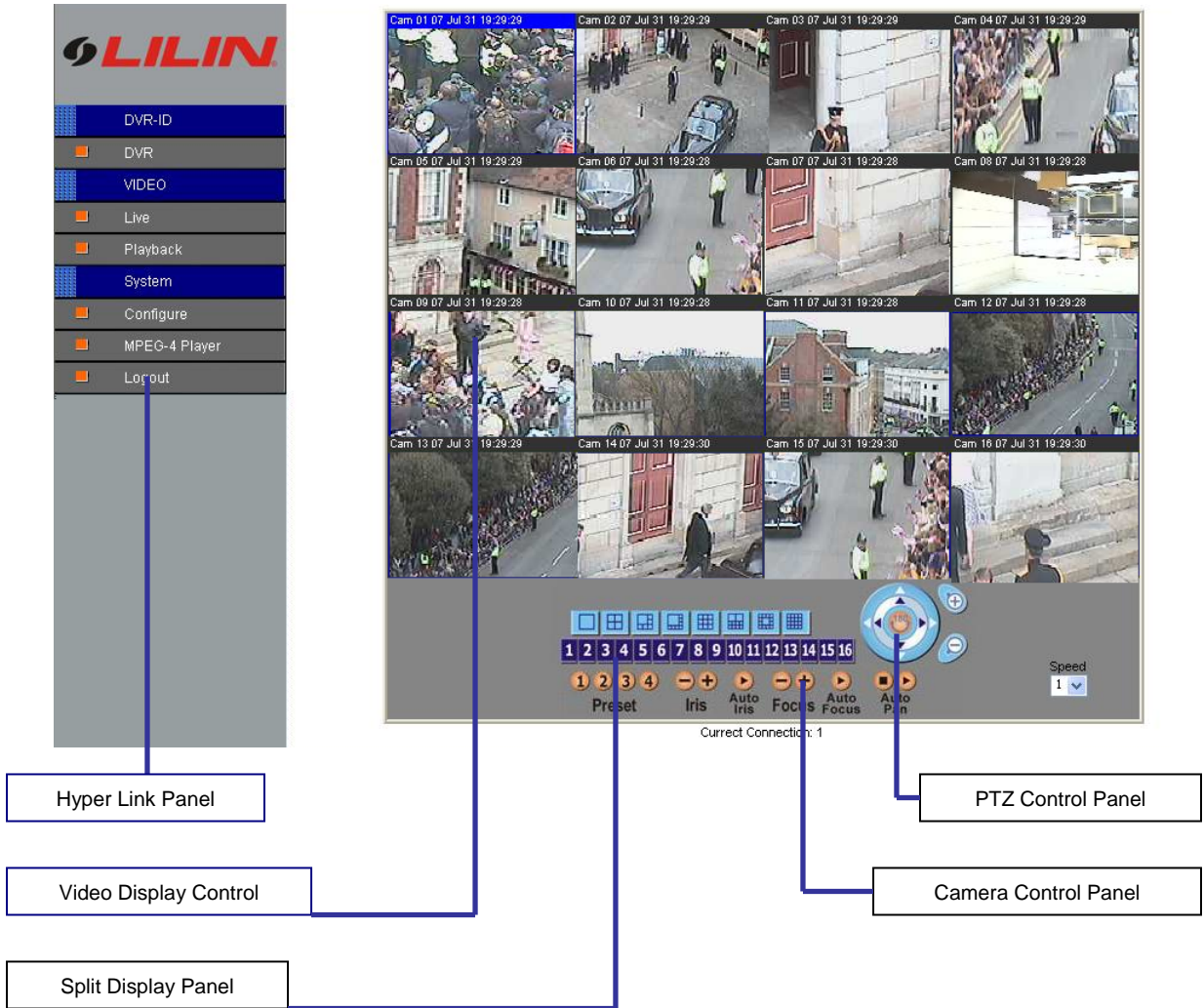

Chapter 8-2-1. Before Using Internet

Make sure that your Internet Browser allows signed ActiveX plug-in running on your PC. Set “Download Signed ActiveX plug-in controls” to “Prompt” and “Run ActiveX control and plug-in” to “Enable” at Internet Explore->Tools->Options->Security Settings.

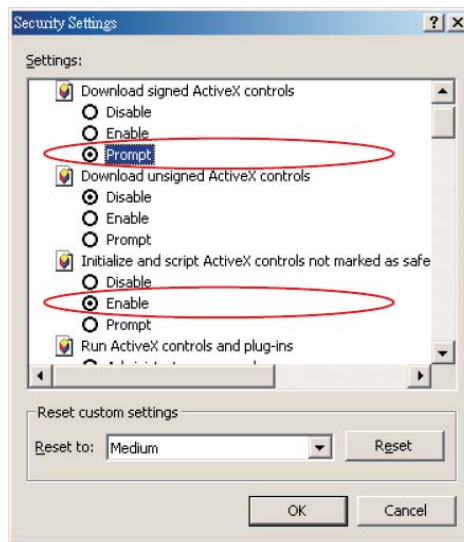

Chapter 8-2-2. Logon

To logon the DVR, please type in the IP address in the HTTP address box via Internet browser. By default, type “192.168.1.171” in the HTTP address box to access the logon page. Use default password “1111” for Administrator, password “2222” for Operator, and password “3333” for Guest.

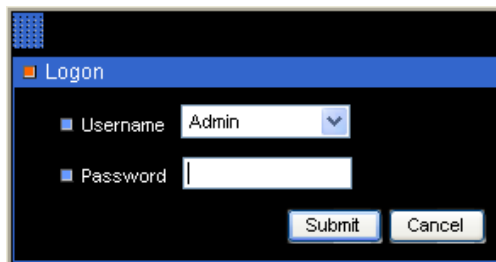









Note: Each user can be assigned for different access level at System->Password/Access.

Chapter 8-2-3. Show Frame Size

To show frame size on each camera channel, please perform right mouse click on Video Control Display area. A system menu shows up and select Show Frame Size menu item. The frame size in Kbytes gets displayed on the right hand side of each camera caption. The frame size information is very important information to determine bandwidth required for operating the DVR.

Chapter 8-2-4. Split Window Display Buttons

Buttons	Split Display	Buttons	Split Display
	Single display		9 split display
	4 split display		10 split display
	6 split display		13 split display
	8 split display		16 split display

Chapter 8-2-5. Hyper Link Panel

Hyper Link Panel contains major features including video source, configuration, and MP4Player.exe download page.

Configure the DVR via Web page

To configure the DVR via web page, please Click on “Configure” hyper link. There are internal server setting, general network setting, PTZ device setting, and video system setting allowed. The detail settings are described in the rest of the chapter.

Download MPEG-4 DVR File Player

MPEG-4 DVR File Player hyper link allows a user to download the application via Internet.

Chapter 8-2-6. Playback Over Network

The DVR allows a user to perform Play, FF, Pause/Step, and Stop operations on a remote DVR. The buttons are described in the following figure:

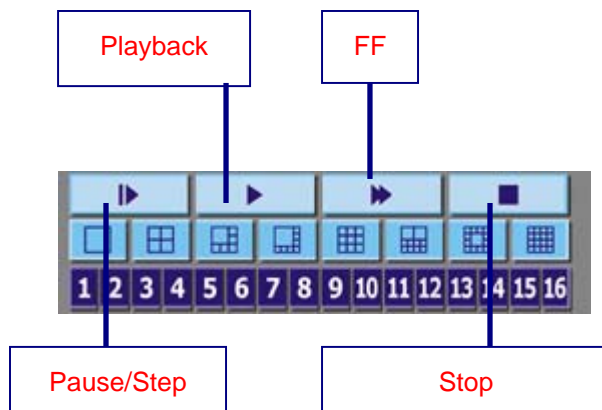

To perform playback operation, please click on Playback hyperlink. A playback dialog box shows up. Event search list, record search list, and time search are all integrated in the dialog box on the hyper link panel.



Normal Record and Event Lists

Double click on the record list item or event list item for playback. A user can also click on Search button to retrieve the video.

Time Search

Time search feature allows a user to search both master and slave HDDs by date and time. To perform time search function, please specify date and time information in date and time edit boxes. Press Search button to finish this task.



Chapter 8-2-7. Save JPEG file

To save live or playback video to JPEG files, please perform right mouse click on Video Display Control area. In system menu, select Save All as JPEG or Save JPEG for the live or playback video.

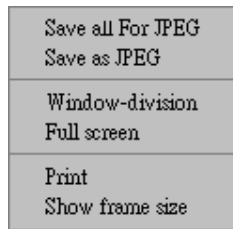

Chapter 8-2-8. Network Audio

The DVR can provide network audio monitoring for both live and playback video. To activate network audio, please open a camera's video in full screen on Video Display Control. It can deliver network audio to a PC for both live and playback video.

Chapter 8-3. Configure the DVR via Web page

Features of the DVR's main menu system can be configured via web interface. Features such as camera, alarm, recording, network, and backup can all get setup remotely.

Chapter 8-3-1 Camera Setting

Noise Filter—Enable or disable noise filter

Channel Enable—Enable or disable live video on main monitor

Sequence Time—Camera sequence time for main monitor

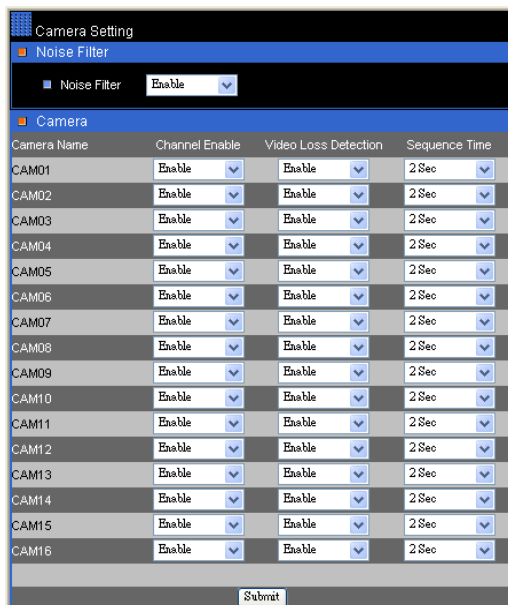

Chapter 8-3-2 Recording Setting

Current Rec Mode—Current DVR recording mode

HDD Overwritten—Option for circular recording

Camera Recording Mode--Assign schedule recording or no recording for a camera.

Camera Quality—Setup the recording quality for a camera

Camera FPS—recording frame rate for a camera

Camera Name	Recording Mode	Quality	FPS
CAM01	Schedule	Highest	8
CAM02	No Recording	High	8
CAM03	No Recording	High	8
CAM04	No Recording	High	8
CAM05	No Recording	High	8
CAM06	No Recording	High	8
CAM07	No Recording	High	8
CAM08	No Recording	High	4
CAM09	No Recording	High	8
CAM10	No Recording	High	8
CAM11	No Recording	High	8
CAM12	No Recording	High	8
CAM13	No Recording	High	8
CAM14	No Recording	High	8
CAM15	No Recording	High	8
CAM16	No Recording	High	4

Total Frames:120/120

Submit

Chapter 8-3-3 Recording Schedule Table

A user can setup record schedule table via Internet, to setup scheduling table, please specify day and time with the recording mode. The user can also use Apply

Schedule Table

	0	1	2	3	4	5	6	7	8	9	10	11	12	13	14	15	16	17	18	19	20	21	22	23
Monday																								
Tuesday																								
Wednesday																								
Thursday																								
Friday																								
Saturday																								
Sunday																								

Always
 Sensor
 Motion
 No Record

Schedule Setting

Schedule Setting By Hour

Day: Monday Hour: 0:00 Mode: Always Submit

Apply All

Mode: Always Submit

Chapter 8-3-4 Alarm Setting

Buzzer Enable—Enable/disable DVR buzzer

Motion Enable—Enable/disable motion detection

Motion Tracer—Enable/disable motion trace

Alarm Input Type—Set alarm input as NO/NC or disable

Buzzer Output Time—Assign buzzer time for each camera

The screenshot shows the 'Alarm Setting' interface. At the top, there is a 'Buzzer Enable' dropdown menu set to 'OFF'. Below this is a table with columns for Camera Name, Motion Enable, Motion Area, Motion Tracer, Alarm Input Type, Alarm Output Time, and Buzzer Output Time. The table lists 16 cameras (CAM01 to CAM16) with their respective settings. A 'Submit' button is located at the bottom of the table.

Camera Name	Motion Enable	Motion Area	Motion Tracer	Alarm Input Type	Alarm Output Time	Buzzer Output Time
CAM01	ON	ON	ON	OFF	2Sec	2Sec
CAM02	ON	ON	OFF	OFF	2Sec	2Sec
CAM03	ON	ON	OFF	OFF	2Sec	2Sec
CAM04	ON	ON	OFF	OFF	2Sec	2Sec
CAM05	ON	ON	OFF	OFF	2Sec	2Sec
CAM06	ON	ON	OFF	OFF	2Sec	2Sec
CAM07	ON	ON	OFF	OFF	2Sec	2Sec
CAM08	ON	ON	OFF	OFF	2Sec	2Sec
CAM09	ON	ON	OFF	OFF	2Sec	2Sec
CAM10	ON	ON	OFF	OFF	2Sec	2Sec
CAM11	ON	ON	OFF	OFF	2Sec	2Sec
CAM12	ON	OFF	OFF	OFF	2Sec	2Sec
CAM13	ON	ON	OFF	OFF	2Sec	2Sec
CAM14	ON	ON	OFF	OFF	2Sec	2Sec
CAM15	ON	ON	OFF	OFF	2Sec	2Sec
CAM16	ON	ON	OFF	OFF	2Sec	2Sec

Chapter 8-3-5 Alarm E-mail

Enable Alarm E-Mail—Option for enable alarm/motion email

From—From E-Mail address

To—To E-Mail address

Host/IP Address—SMTP mail server's IP or DNS address

Authentication—Option for user and password authentication

E-Mail Account—receiver's E-Mail account

E-Mail Password—receiver's E-Mail account's password

The screenshot shows the 'Alarm Mail' configuration interface. It includes a 'Enable Alarm Mail' checkbox (checked), a 'From' field (user@example.com), a 'To' field (user@example.com), a 'Host/IP Address' field (example.com), an 'Authorization' checkbox (checked), an 'E-Mail Account' field, and an 'E-Mail Password' field. A 'Submit' button is located at the bottom.

Chapter 8-3-6 Network Setting

IP Address—DVR's IP address

Subnet Mask—Subnet mask

Gateway IP Address—Router/Gateway IP address

Video Port—The DVR's video port

HTTP Port—HTML port number

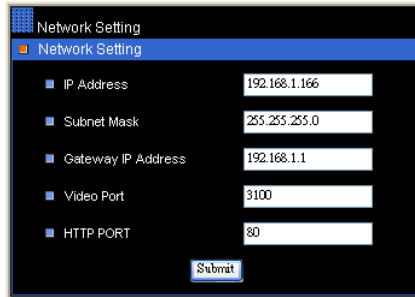

The screenshot shows the 'Network Setting' menu with the following fields:

IP Address	192.168.1.166
Subnet Mask	255.255.255.0
Gateway IP Address	192.168.1.1
Video Port	3100
HTTP PORT	80

Submit

Chapter 8-3-7 System Setting

MAC Address: MAC address of the DVR

Firmware: firmware version of the DVR

DVR/485 ID: Addressable DVR ID for multiple DVRs remote control using remote controller and RS-485 keyboard.

Language: Language selection of the DVR

Max Connections: Maximum network connections allowed for the DVR

Auto Logout: force to logout remote accesses.

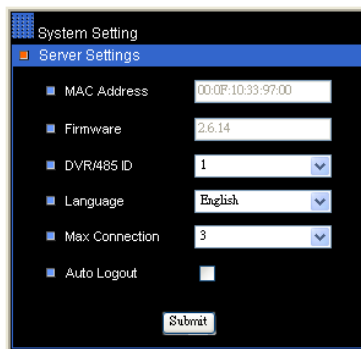

The screenshot shows the 'System Setting' menu with the following fields:

MAC Address	00:0F:10:33:97:00
Firmware	2.6.14
DVR/485 ID	1
Language	English
Max Connection	3
Auto Logout	<input type="checkbox"/>

Submit

Chapter 8-3-7-1 Timer

Date: Current date of the DVR

Time: Current time of the DVR

DST: Daylight saving time for a region

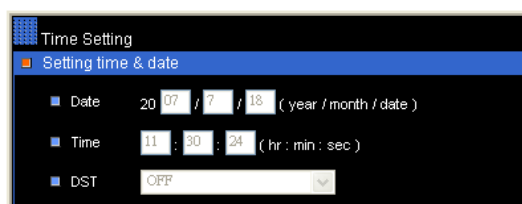

The screenshot shows the 'Time Setting' menu with the following fields:

Date	20 07 / 17 / 18 (year / month / date)
Time	11 : 50 : 24 (hr : min : sec)
DST	OFF

Chapter 8-3-7-2 User Setting

There are three levels (admin, operator and guest) of user authentication allowed in the DVR. To change password, please specify the old password, new password, and confirm password.

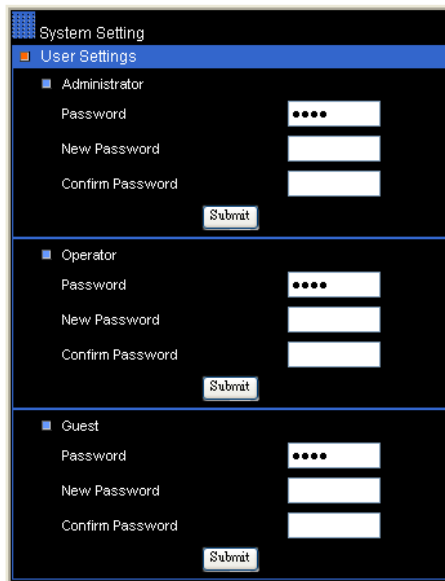

The screenshot displays the 'System Setting' menu with 'User Settings' selected. It features three sections for user authentication: Administrator, Operator, and Guest. Each section contains three input fields: 'Password' (masked with dots), 'New Password', and 'Confirm Password', followed by a 'Submit' button.

Chapter 8-3-7-3 System Status

Primary Master HDD—HDD detecting status of primary master IDE channel for the DVR

Primary Slave HDD—HDD detecting status of primary slave IDE channel for the DVR

Secondary Master HDD—HDD detecting status of secondary master IDE channel for the DVR

Secondary Slave HDD—HDD detecting status of secondary slave IDE channel for the DVR

HDD Recording Start—Start recording time of the DVR

HDD Recording End—End recording time of the DVR

Approximate Rec Hours—Total recording hours available for the HDD(s)

Approximate Rec Days—Total recording days available for the HDD(s)

Current Written HDD—The HDD of the DVR in writing

Already Overwritten—The HDD(s) has been overwritten.

DVR ID—DVR ID/RS-485 ID

Number of Connections—Number of users accessing the DVR via network

Last Reboot Time—Last time for rebooting the DVR

Kernel—The OS version of the DVR

System Status	
HDD Status	
■ Primary Master HDD	Not Installed
■ Primary Slave HDD	Not Installed
■ Second Master HDD	Not Installed
■ Second Slave HDD	Installed
■ HDD Recording Start	07/08/21 12:05:42
■ HDD Recording End	07/08/23 08:56:01
■ Approximate Rec Hours	118
■ Approximate Rec Days	4
■ Current Written HDD	Second Slave
■ Already Overwritten	No
DVR Status	
■ DVR ID	1
■ Number of Connections	2
■ Last Reboot Time	08/23 08:34
■ Kernel	2.6

Chapter 8-3-7-4 Firmware update

This DVR is allowed to perform firmware upgrade via network. After DVR receives the firmware, it starts to perform firmware upgrade automatically. After finishing the firmware update, HTML page gets reload. The user can then start to operator the DVR.

Firmware Update	
<p>■ Please do not turn off power and wait until this web page shows up automatically. Fail to update firmware correctly due to network communication issue that it may damage this machine and is required to ship back to your vender for repair.</p>	
■ Firmware	<input type="text"/> <input type="button" value="Browse"/>
<input type="button" value="Submit"/> <input type="button" value="Cancel"/>	

To perform network firmware update, please click on Browse button and locate the firmware. For 4-channel, 8-channel, and 16-channel, the firmware files are flash604.bin, flash608.bin, and flash616.bin respectively.

Chapter 8-3-8 Backup

To perform remote video file backup, click Backup hyperlink. Please specify starting time and ending time. Click on Submit button to perform file backup task.

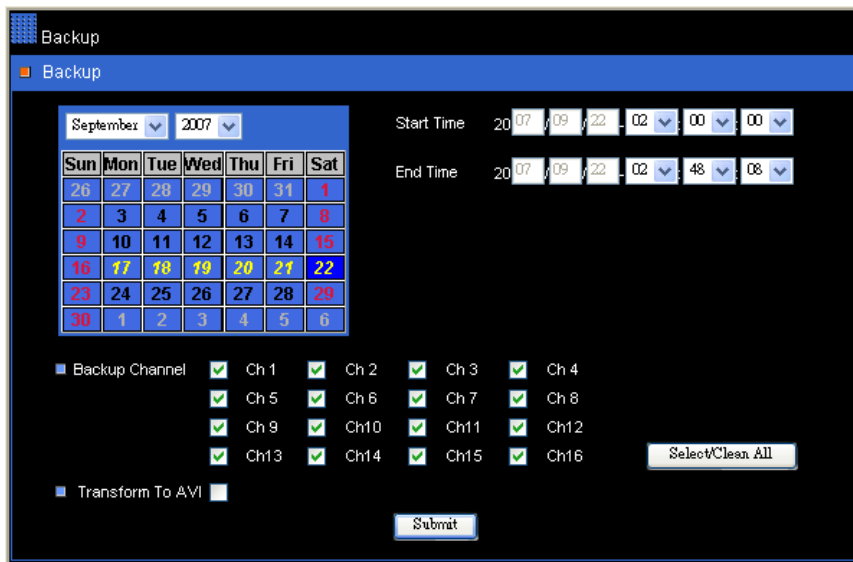

A backup progress bar shows up on the web page. After backup task ends, please click on the file hyperlink with LMP file extension. It can download the file from the DVR's internal FTP server to your local PC.

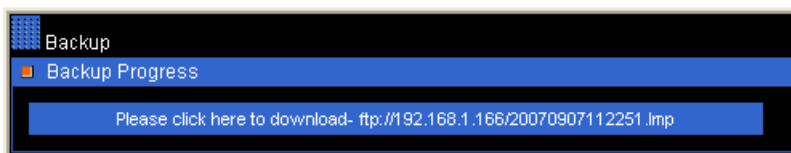
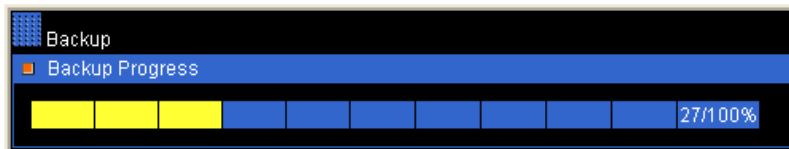

To download the backup file(s) again, please click on "Backup File Download" hyperlink to download.

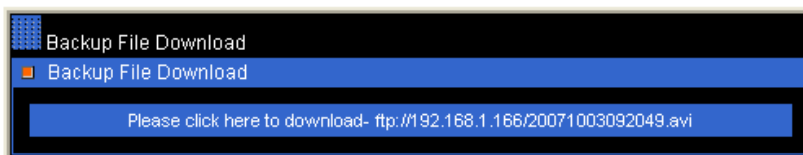

KEYBOARD CONNECTONS

CHAPTER 9. KEYBOARD CONNECTION

Chapter 9-1. Connection Between a DVR and a Keyboard

To operate a DVR with a keyboard, please directly connect PIH-931 keyboard to the DVR's keyboard input using a RJ-45 cable. The DVR provides DC 12V for PIH-931 keyboard. There is no need for connecting power adapter.

DVR & Keyboard Connection Diagram

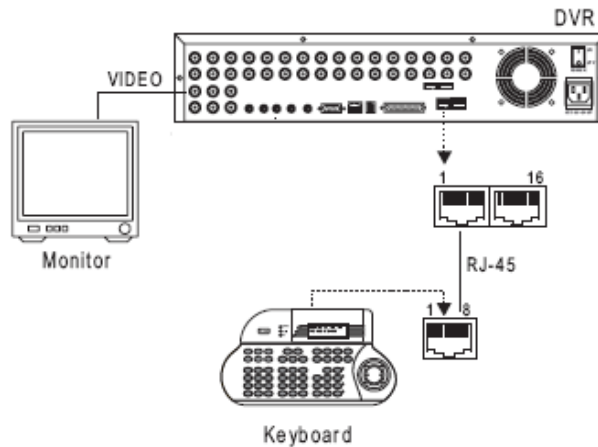

Note: Only 8-channel and 16-channel DVRs can support keyboard connection.

Chapter 9-2. Daisy Chain Connections of DVRs and a Keyboard

To connect PIH-931D a keyboard with multiple DVRs, connect the RJ-45 cable from PIH-931D keyboard to the DVR's RJ-45 keyboard input. The DVRs are connected in daisy chain from the DVR's keyboard output to the next DVR's keyboard input. There are up to 255 DVRs can be connected and addressed. For setup DVR/RS-484 ID, please read Menu->System->DVR/RS-485 section first

DVRs System Diagram

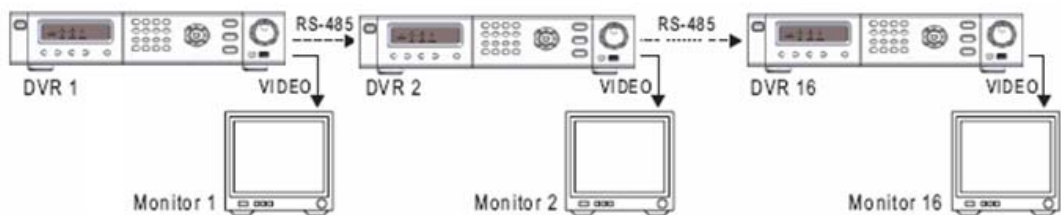

DVRs Connection Diagram

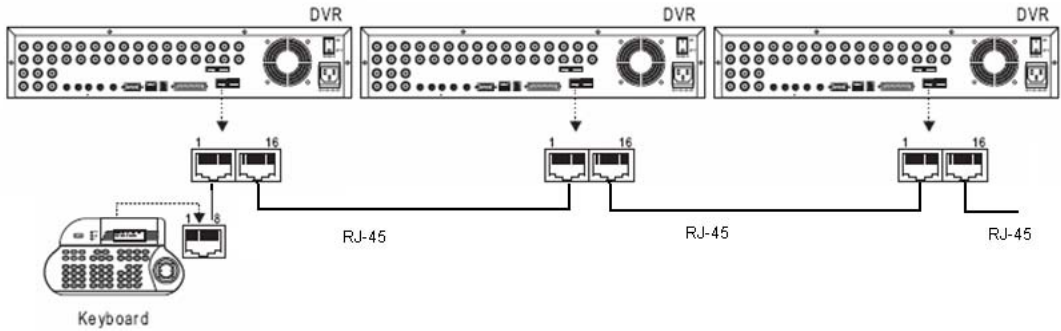

Note: To address multiple DVRs, please setup DVR/RS-485ID for every DVR first.

Chapter 9-3. Connections between a DVR and multiple PTZs

Please use twisted pair cable to connect a PTZ to a DVR. The connections between PTZs, please refer PTZs' user manual.

DVRs & PTZs System Diagram

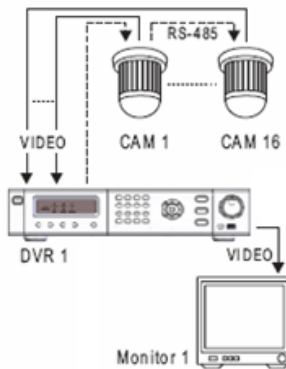

DVRs & PTZs Connection Diagram

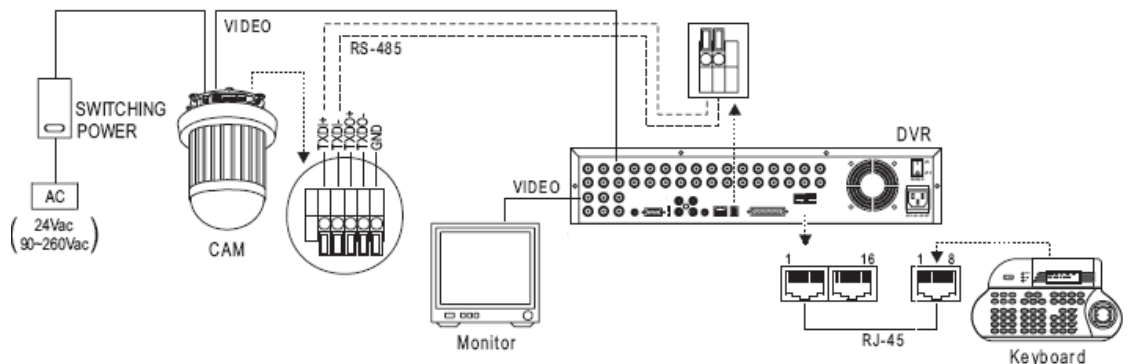

Chapter 9-4. Connection between multiple DVRs and multiple keyboards

To connect multiple DVRs and multiple keyboards, please use Connector Box shipped with the PIH-931D keyboard. Connections between keyboards, use a twisted pair cables to connect two Connector Boxes. The detail is in the following connection diagram. The connection between DVRs, please use RJ-45 cable to connect.

Multiple DVRs & Multiple PTZs System Diagram

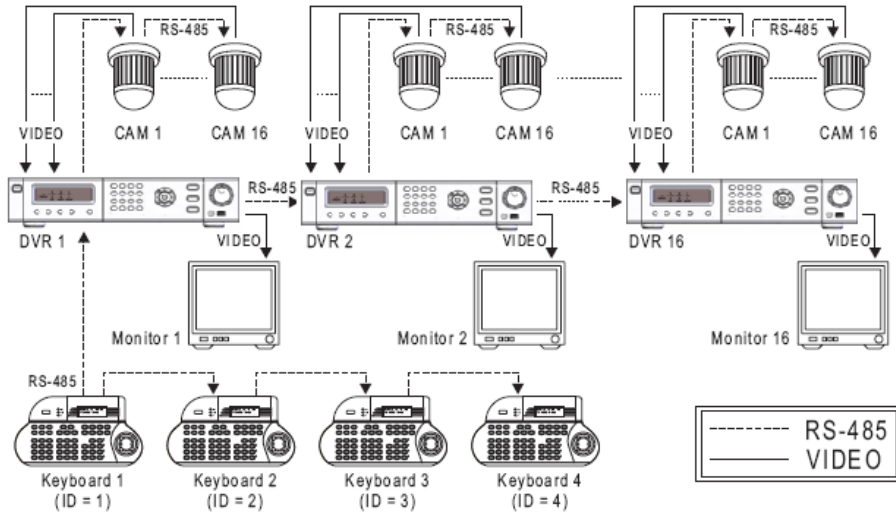

Multiple DVRs & Multiple PTZs Connection Diagram

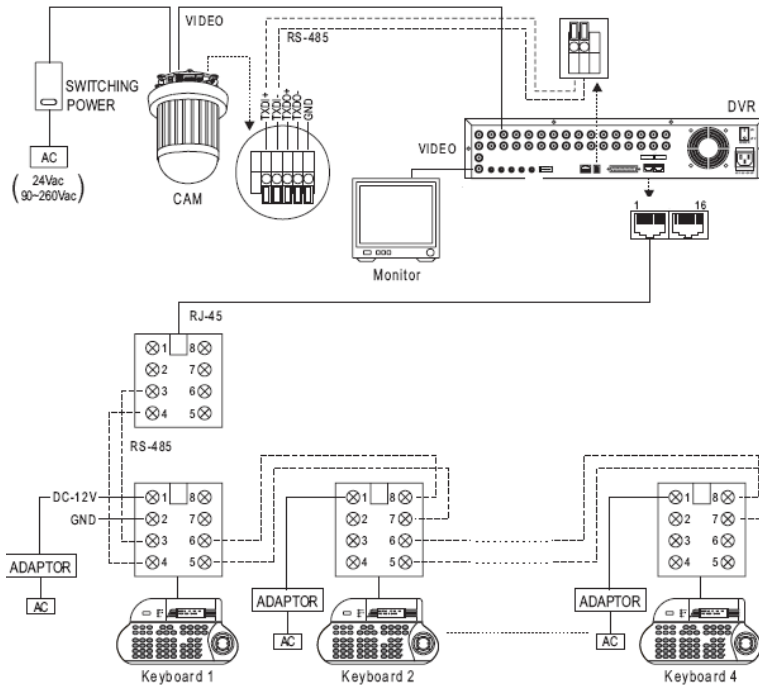

Chapter 9-5. Operating a Keyboard for Controlling DVRs and PTZs

There are four main DVR features including multiplexer, menu setup, PTZ control, and playback controllable by the keyboard controller. To operate DVR by PIH-931 keyboard, please follow the following sections:

Chapter 9-5-1. Switch to DVR Control Mode

Press the **SHIFT** button and the **DVR** button to set the keyboard controller to the DVR operation mode.

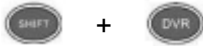

2006/01/01 12:00:00
DVR MODE ID=000

Chapter 9-6. Control DVR's Multiplexer Features

A DVR's multiplexer features include calling a camera displayed on a monitor, window-division, and camera sequence display. The details are described in the following:

Control a DVR

Enter a number from 1~255 using the number pad and press the **DVR** button to select the DVR.

2007/01/01 12:00:00
DVR MODE ID=xxx

Example: Control DVR #12.



Call a Camera Displayed on Main Monitor

After a DVR gets controlled, enter a number from 1 to 16 using the number pad and press the **CAM** button to select the camera.

Example: Call camera #8 of DVR #12.

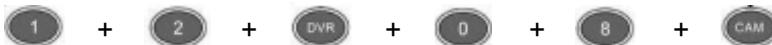

Directly access a camera of a particular DVR. Enter the camera's ID (1~4080) and press **CAM** button. The camera ID gets resolved to its DVR by keyboard controller.

Example #1: Call camera #17 (DVR #2's first camera).



2006/01/01 12:00:00
DVR MODE ID=002
CAM=001





Example #2: Enter camera number 128 and press the CAM button. This calls DVR #8's camera #16.

2006/01/01 12:00:00
DVR MODE ID=008
CAM=016



Window-division on Main Monitor

To perform window division feature of a DVR, press the following window division buttons.

-  16 window-division
-  9 window-division
-  8 window-division
-  4 window-division (Quad screen)









DVR Sequential Display on Main Monitor

Press **SEQ** button to display cameras' full screen in a sequence with specific time period.

Chapter 9-7. Control DVR's Menu Setup

After a DVR gets controlled. Press the **SET** button to activate the DVR's setup menu.

Menu Setup Using 3D Joystick

	Enter a submenu		ESC/Exit a submenu
	Move cursor up		Move cursor down
	Decrease a digit		Increase a digit
	Enter a submenu		ESC/Exit a submenu

Chapter 9-7-1. OK or Cancel button in Submenu System







There are OK or Cancel button in submenu system. The shortcut buttons are **SET** or **ESC** button on the keyboard.

Chapter 9-8. Control DVR Playback







To perform DVR playback feature, press **Play** button or **Search** button.

Play button can invoke playback menu. Use 3D joystick to move menu cursor and perform playback feature.

Search button can invoke time search feature of the DVR. Use 3D joystick to move menu cursor.

	<ol style="list-style-type: none"> 1. Enter a submenu in playback menu 2. Fast forward video in playback mode 		<ol style="list-style-type: none"> 1. ESC/Exit a submenu in playback menu 2. Fast reverse video in playback mode
	Move cursor up		Move cursor down
	Decrease a digit		Increase a digit

Video Playback Operations













-  Pause: Press **PAUSE** button during playing video can pause the video in pause mode.
-  Play: Replay the video after Pause, Fast Forward, or Fast Rewind.
-  Fast Forward: Fast Forward the playback video.
-  Fast rewind: Fast Rewind the playback video.
-  Stop: Stop the playback video and return to playback menu.
-  Record/Stop Record: Perform DVR record or stop DVR recording operation.

Select various split display modes on live and playback monitoring.

Chapter 9-9. Control PTZ

To control PTZ camera in live monitoring mode, press **Enter** button to gain camera control sequentially in window-division mode or perform call camera in full screen mode.

Once a camera of a DVR gets controlled, the following PTZ operations can be performed.

	Zoom in		Zoom out
	Tilt up		Tilt down
	Pan left		Pan right
	Zoom in		Zoom out
	Focus far		Focus near
	IRIS large		IRIS small
	Auto Pan		

Chapter 9-9-1. Recall a Preset

To recall a preset point of a PTZ device, please press number key and followed by Preset key.

Example #1: Recall preset #16 of camera #21.

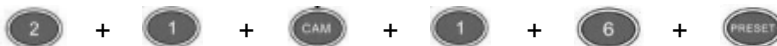

Chapter 9-10. Control a DVR's Spot Monitor

A user can also use a PIH-931D keyboard to control DVRs' spot monitors. The spot monitor is equipped with a Quad processor for quad screen accessed by a keyboard. Sequence feature of spot monitor can also be accessed.

Call a Camera Displayed on a Spot Monitor

After a DVR gets controlled, press #1 + **MON** for spot monitor output and enter a number from 1 to 16 using the number pad followed by the **CAM** button to select the camera.

Example: Call camera #8 displayed on DVR #12's spot monitor .

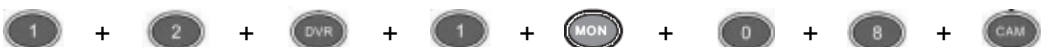

Quad Screen Displayed on a Spot Monitor

After a DVR gets controlled, press #1 + MON for spot monitor output followed by 4 window-division button.

Example: Show quad screen displayed on DVR #12's spot monitor .

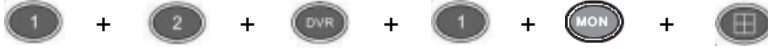

Perform Sequence on a Spot Monitor

After a DVR gets controlled, press #1 + MON for spot monitor output and followed by the SEQ button.

APPENDIX

APPENDIX A. Connect to External SATA RAID

To connect SATA to external SATA RAID:

1. Power off the DVR.
2. Open the case of the DVR.
3. Plug SATA cable to the external SATA connector.

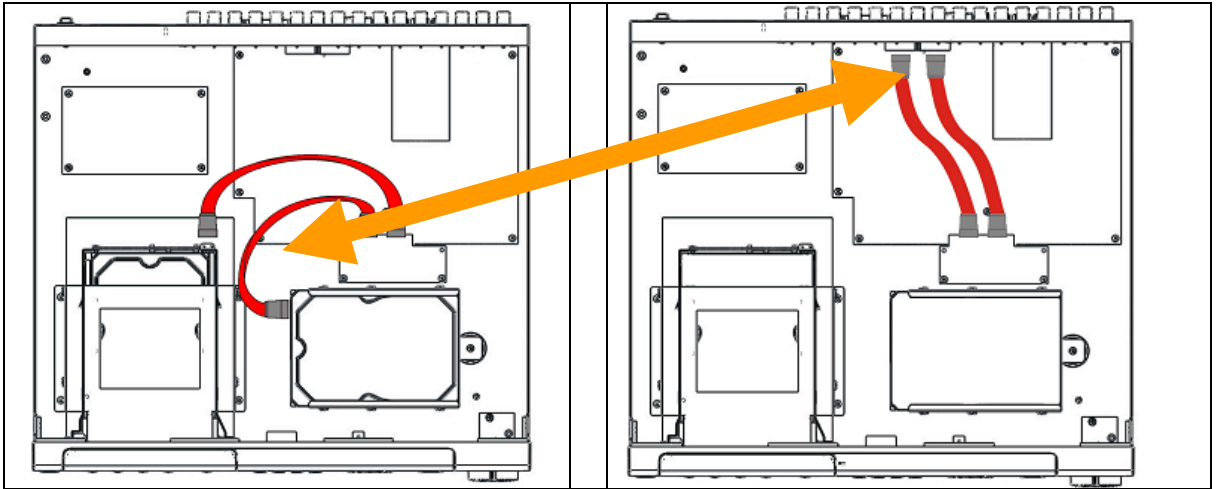

4. Close the case of the DVR.
5. Connect the DVR to external SATA RAID using SATA cable.
6. Power on the DVR.

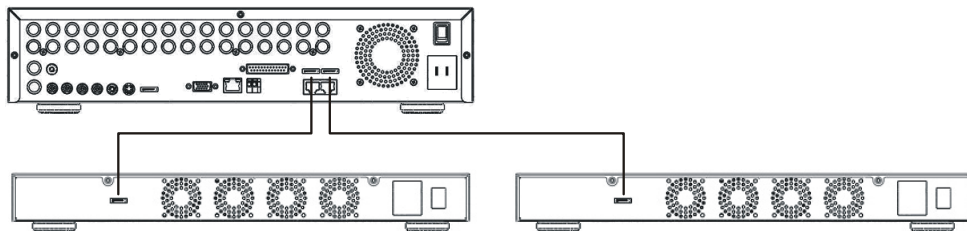

Caution: The DVR does NOT support N-RAID mode. Please change PSH-100's setting to RAID-0 or RAID-1.

APPENDIX B. Connect External Alarm Switches

For 8/16-Ch DVR, it has a D-SUB 25-pin I/O connector which contains 16 alarm switch inputs (dry contact) and two alarm outputs. The detail description of the pin assignment is in the following charts.

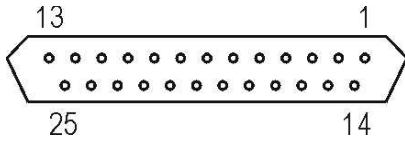

Alarm Switch Pin Assignment Table

Pin 1	Alarm input 1	Pin 14	Alarm input 13
Pin 2	Alarm input 2	Pin 15	Alarm input 14
Pin 3	Alarm input 3	Pin 16	Alarm input 15
Pin 4	Alarm input 4	Pin 17	Alarm input 16
Pin 5	Alarm input 5	Pin 18	
Pin 6	Alarm input 6	Pin 19	
Pin 7	Alarm input 7	Pin 20	GND
Pin 8	Alarm input 8	Pin 21	ALARM COM
Pin 9	Alarm input 9	Pin 22	ALARM NC (normal close)
Pin 10	Alarm input 10	Pin 23	ALARM NO (normal open)
Pin 11	Alarm input 11	Pin 24	GND
Pin 12	Alarm input 12	Pin 25	GND
Pin 13	GND		

For 4-Ch DVR, it has 8-pin I/O connector which contains 4 alarm switch inputs (dry contact) and two alarm outputs. The ping assignment is in the following charts.

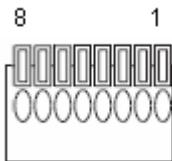

Pin 1	Alarm input 1
Pin 2	Alarm input 2
Pin 3	Alarm input 3
Pin 4	Alarm input 4
Pin 5	GND
Pin 6	ALARM NO (normal open)
Pin 7	ALARM NC (normal close)
Pin 8	COM

APPENDIX C. RS-485 Input and Output Pin Assignment

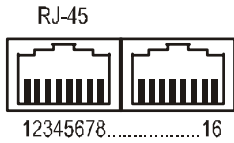

Terminal	Name
1	--
2	--
3	--
4	--
5	RS-485 – Out Link Keyboard
6	RS-485 + Out Link Keyboard
7	GND
8	DC +12V input
9	--
10	--
11	--
12	--
13	RS-485 - DVR
14	RS-485 + DVR
15	GND
16	--

RS-485 PTZ Terminal Pin Assignment

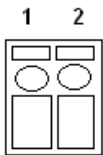

Terminal	Name
1	RS-485 + for PTZ
2	RS-485 – for PTZ

RS-485+ RS-485-

APPENDIX D. Hard Disk Drive Support List

Model	HDD Size
Seagate Barracuda ST316020811AS	160GB
Seagate Barracuda ST3200827AS	200GB
Seagate Barracuda ST32506AS	250GB
Seagate Barracuda ST3400620AS	400GB
Seagate Barracuda ST3500630AS	500GB
Western Digital WD1600AVJS	160GB
Western Digital WD2500AVJS	250GB
Western Digital WD3200AVJS	320GB
Western Digital WD4000AVJS	400 GB

APPENDIX E. Supported DVD/RW Drive

Manufacturer	Model
ASUS	DRW-1608P3S
Lite-On	LH-20A1P
NEC	ND-3550A

APPENDIX F. Hard Disk Recording Table

Approximate recording days and hours can also be found at Menu->System->HDD Info.

Recording Quality		Very high		High		Normal		Low	
HDD	Picture size	8.2	KB/Pic	5.8	KB/Pic	2.9/Pic	KB/Pic	1.6	KB/Pic
120	GB	1.8	Days	2.5	Days	5.0	Days	9.1	Days
250	GB	3.7	Days	5.2	Days	10.5	Days	19.0	Days
400	GB	5.9	Days	8.4	Days	16.7	Days	30.3	Days
500	GB	7.4	Days	10.5	Days	20.9	Days	37.9	Days
750	GB	11.1	Days	15.7	Days	13.0	Days	56.9	Days
1000	GB	14.8	Days	20.9	Days	41.8	Days	75.9	Days
2000	GB	29.6	Days	41.8	Days	83.7	Days	151.7	Days
4000	GB	59.2	Days	83.7	Days	167.4	Days	303.4	Days

Note: #1. Recording frame rate is 120(NTSC)/100(PAL) picture per second at CIF in resolution.

#2. Above information may be inaccurate due to the installation environment.

Specification

	PDR-6160A/S	PDR-6080A/S	PDR-6040A/S
Models	A: Removable HDD tray * 1, internal HDD * 1 with DVD/RW S: Internal HDD * 2		A: Internal HDD * 1 with DVD/RW S: Internal HDD * 2
Recording medium	SATA HDD: * 2		SATA HDD: internal * 1 (A), Internal * 2 (S)
Recording mode	External alarm / motion detection / schedule / manual		
Speed	PAL: 50 Field/Sec or 100 CIF/Sec NTSC: 60 Field / Sec or 120 CIF/Sec, 1.2 to 8.2 KB/CIF		
NRF	Noise Reduction Filter, configurable for night		
Resolution	720*240 (Field) / 320*240 (CIF)		
Schedule	7 day * 24 hrs time table, recording mode configurable		
External RAID	e-SATA interface * 2 up to 4TB		e-SATA interface * 1 up to 2 TB
Frame rate	Configurable for each channel		
Backup	USB 2.0 flash disk / DVD/RW (A) / FTP file download / Audio supported		
DVD/RW drive	4.0GB		
DVD format	DVD+RW, DVD+R, AVI/MPEG-4 video with ISO-9660 compatible, plug-n-play		
Playback	Manual record, time search, event search, date search		
Speed	FR: 2x, 4x, 6x / FF: 2x, 4x, 6x		
Compression	MPEG-4		
Video Input	BNC * 16 (1Vp-p, 75Ω)	BNC * 8 (1Vp-p, 75Ω)	BNC * 4 (1Vp-p, 75Ω)
Camera Name	12 characters		
Looping	BNC * 16 (1Vp-p, 75Ω)	BNC * 8 (1Vp-p, 75Ω)	None
Live	PAL: 400 FPS NTSC: 480 FPS	PAL: 200 FPS NTSC: 240 FPS	PAL: 100 FPS NTSC: 120 FPS
Channel Editing	Mouse drag-n-drop		
Video Out	1 BNC (1Vp-p, 75Ω)		2 BNC (1Vp-p, 75Ω)
VGA output	Intellectual motion adoptive refinement with vivid image enhancement VGA engine		
Multiplexer	Sequence / digital zoom / freeze		
Split screen	4, 8, 9, 13, 16, PIP	4, 9, PIP	4, PIP
Spot	Spot with quad output, sequence, keyboard control, and alarm switching		None
Alarm	Alarm in * 16 / out * 2 (NO/NC)	Alarm in * 8 / out * 2 (NO/NC)	Alarm in * 4 / out * 2 (NO/NC)
Motion	Motion grid 30*24 each channel, 8 sensitivities, motion tracer		
Event	External alarm, video loss, stop recording, power recovering, motion detection, schedule, logon, HDD format		
Recording	Pre-alarm (up to 160 images) and post-alarm		
Accessories	Remote controller addressable up to 255 DVRs		
P/T/Z protocol	Merit LILIN all series, Pelco P/D protocol, remote controllable, Web		Via RS-232
Keyboards	PIH-931 keyboard addressable up to 255 DVRs		None
IR receiver	Extra IR extension connector, up to 200 m		None
RS-485/RS-232	RS-485 keyboard connector * 2, 12V output, RS-485 PTZ output * 1		PTZ connection
Jog & shuttle	FF, FR, Step, instant rewind, menu setup		None
Mouse	USB / PS-2, drag-n-drop, right-mouse-click, mouse wheel.		
Audio	RCA * 4 input / RCA * 1 output (0.7Vp-p, 300 Hz to 3KHz)		
Network	Direct Internet browser access / multiple users access / free CMX / audio		
Protocols	ARP / TCP/IP / HTTP / SMTP / FTP / DDNS		
Web setup	Full features with remote firmware upgradable		
API	HTTP API / ActiveX / SDK supported		
Web	Live / event log & time search playback / AVI / snapshot		
IPScan	Supported, easy-to-setup for IP address		
User authentication	Three level: admin, operator, and guest, feature configurable		
WDT	Hardware watchdog timer		
DST	Daylight saving time		
LRA	Limited recording access		
Multilanguage	English, Chinese, Spanish, Danish, Swiss, Norwegian, Arabic, Japanese, Germany, French, Polish		
CPU/OS	32-bit RISC Processor, 333 MHz/ Linux 2.6 Kernel		
Power	AC 110V / 220V Max., 135W		
Working Env.	Temp: 0°C ~ +50°C / Humidity: 0%~80%		
Dimension	434mm x 411.4mm x 88mm	434mm x 411.4mm x 88mm	434 mm x 364.3 * 52.8 mm
Weight	8.5 Kg w/o HDD	8.5 Kg w/o HDD	5.2 Kg w/o HDD



MERIT LILIN ENT. CO., LTD
<http://www.meritlilin.com>

66-6160CSE